



# **SiFive E34 Core Complex Manual**

## **21G1.01.00**

Copyright © 2018–2021 by SiFive, Inc. All rights reserved.

# SiFive E34 Core Complex Manual

## Proprietary Notice

Copyright © 2018–2021 by SiFive, Inc. All rights reserved.

SiFive E34 Core Complex Manual by SiFive, Inc. is licensed under Attribution-NonCommercial-NoDerivatives 4.0 International. To view a copy of this license, visit: <http://creativecommons.org/licenses/by-nc-nd/4.0>

Information in this document is provided “as is,” with all faults.

SiFive expressly disclaims all warranties, representations, and conditions of any kind, whether express or implied, including, but not limited to, the implied warranties or conditions of merchantability, fitness for a particular purpose and non-infringement.

SiFive does not assume any liability rising out of the application or use of any product or circuit, and specifically disclaims any and all liability, including without limitation indirect, incidental, special, exemplary, or consequential damages.

SiFive reserves the right to make changes without further notice to any products herein.

# Contents

<b>List of Tables</b> .....	8
<b>List of Figures</b> .....	12
<b>1 Introduction</b> .....	15
1.1 About this Document .....	15
1.2 About this Release .....	16
1.3 E34 Core Complex Overview .....	16
1.4 E3 RISC-V Core .....	17
1.5 Memory System.....	18
1.6 Interrupts .....	18
1.7 Debug Support .....	18
1.8 Compliance .....	18
<b>2 List of Abbreviations and Terms</b> .....	20
<b>3 E3 RISC-V Core</b> .....	23
3.1 Supported Modes .....	23
3.2 Instruction Memory System.....	23
3.2.1 Execution Memory Space .....	23
3.2.2 L1 Instruction Cache.....	24
3.2.3 Cache Maintenance.....	24
3.2.4 Instruction Cache Reconfigurability .....	24
3.2.5 Instruction Fetch Unit.....	25
3.2.6 Branch Prediction .....	25
3.3 Execution Pipeline .....	26
3.4 Data Memory System.....	27
3.4.1 Data Tightly-Integrated Memory (DTIM).....	28
3.5 Atomic Memory Operations.....	28

3.6	Floating-Point Unit (FPU).....	28
3.7	Local Interrupts.....	29
3.8	Physical Memory Protection (PMP).....	29
3.8.1	PMP Functional Description .....	29
3.8.2	PMP Region Locking .....	30
3.8.3	PMP Registers.....	30
3.8.4	PMP and PMA .....	32
3.8.5	PMP Programming Overview .....	32
3.8.6	PMP and Paging .....	34
3.8.7	PMP Limitations .....	34
3.8.8	Behavior for Regions without PMP Protection .....	34
3.8.9	Cache Flush Behavior on PMP Protected Region.....	35
3.9	Hardware Performance Monitor.....	35
3.9.1	Performance Monitoring Counters Reset Behavior .....	35
3.9.2	Fixed-Function Performance Monitoring Counters .....	35
3.9.3	Event-Programmable Performance Monitoring Counters.....	36
3.9.4	Event Selector Registers.....	36
3.9.5	Event Selector Encodings .....	36
3.9.6	Counter-Enable Registers .....	38
3.10	Ports.....	38
3.10.1	Front Port .....	38
3.10.2	Peripheral Port.....	39
3.10.3	System Port.....	39
<b>4</b>	<b>Physical Memory Attributes and Memory Map .....</b>	<b>40</b>
4.1	Physical Memory Attributes Overview .....	40
4.2	Memory Map .....	41
<b>5</b>	<b>Programmer's Model.....</b>	<b>43</b>
5.1	Base Instruction Formats.....	43
5.2	I Extension: Standard Integer Instructions .....	44
5.2.1	R-Type (Register-Based) Integer Instructions.....	45
5.2.2	I-Type Integer Instructions.....	46

5.2.3	I-Type Load Instructions.....	47
5.2.4	S-Type Store Instructions.....	48
5.2.5	Unconditional Jumps.....	49
5.2.6	Conditional Branches.....	50
5.2.7	Upper-Immediate Instructions.....	51
5.2.8	Memory Ordering Operations.....	51
5.2.9	Environment Call and Breakpoints.....	52
5.2.10	NOP Instruction.....	52
5.3	M Extension: Multiplication Operations.....	52
5.3.1	Division Operations.....	53
5.4	A Extension: Atomic Operations.....	53
5.4.1	Atomic Memory Operations (AMOs).....	53
5.5	F Extension: Single-Precision Floating-Point Instructions.....	54
5.5.1	Floating-Point Control and Status Registers.....	54
5.5.2	Rounding Modes.....	55
5.5.3	Single-Precision Floating-Point Load and Store Instructions.....	55
5.5.4	Single-Precision Floating-Point Computational Instructions.....	56
5.5.5	Single-Precision Floating-Point Conversion and Move Instructions.....	56
5.5.6	Single-Precision Floating-Point Compare Instructions.....	58
5.6	C Extension: Compressed Instructions.....	60
5.6.1	Compressed 16-bit Instruction Formats.....	60
5.6.2	Stack-Pointed-Based Loads and Stores.....	61
5.6.3	Register-Based Loads and Stores.....	62
5.6.4	Control Transfer Instructions.....	63
5.6.5	Integer Computational Instructions.....	64
5.7	Zicsr Extension: Control and Status Register Instructions.....	67
5.7.1	Control and Status Registers.....	68
5.7.2	Defined CSRs.....	68
5.7.3	CSR Access Ordering.....	71
5.7.4	SiFive RISC-V Implementation Version Registers.....	72
5.7.5	Custom CSRs.....	73
5.8	Base Counters and Timers.....	73
5.8.1	Timer Register.....	75

5.8.2	Timer API .....	75
5.9	Privileged Instructions .....	76
5.9.1	Machine-Mode Privileged Instructions .....	76
5.10	ABI - Register File Usage and Calling Conventions .....	77
5.10.1	RISC-V Assembly .....	79
5.10.2	Assembler to Machine Code .....	79
5.10.3	Calling a Function (Calling Convention) .....	81
5.11	Memory Ordering - FENCE Instructions .....	84
5.12	Boot Flow .....	85
5.13	Linker File .....	86
5.13.1	Linker File Symbols .....	87
5.14	RISC-V Compiler Flags .....	88
5.14.1	arch, abi, and mtune .....	88
5.15	Compilation Process .....	92
5.16	Large Code Model Workarounds .....	92
5.16.1	Workaround Example #1 .....	93
5.16.2	Workaround Example #2 .....	93
5.17	Pipeline Hazards .....	94
5.17.1	Read-After-Write Hazards .....	94
5.17.2	Write-After-Write Hazards .....	95
5.18	Reading CSRs .....	95
<b>6</b>	<b>Custom Instructions and CSRs .....</b>	<b>97</b>
6.1	CEASE .....	97
6.2	PAUSE .....	97
6.3	Branch Prediction Mode CSR .....	97
6.3.1	Branch-Direction Prediction .....	98
6.4	SiFive Feature Disable CSR .....	98
6.5	Other Custom Instructions .....	99
<b>7</b>	<b>Interrupts and Exceptions .....</b>	<b>100</b>
7.1	Interrupt Concepts .....	100
7.2	Exception Concepts .....	100

7.3	Trap Concepts .....	102
7.4	Interrupt Block Diagram .....	103
7.5	Local Interrupts .....	103
7.6	Interrupt Operation .....	104
7.6.1	Interrupt Entry and Exit .....	104
7.7	Interrupt Control and Status Registers .....	105
7.7.1	Machine Status Register (mstatus).....	105
7.7.2	Machine Trap Vector (mtvec).....	105
7.7.3	Machine Interrupt Enable (mie).....	107
7.7.4	Machine Interrupt Pending (mip).....	107
7.7.5	Machine Cause (mcause) .....	108
7.7.6	Minimum Interrupt Configuration .....	109
7.8	Interrupt Priorities .....	110
7.9	Interrupt Latency .....	110
7.10	Non-Maskable Interrupt .....	111
7.10.1	Handler Addresses .....	111
7.10.2	RNMI CSRs .....	111
7.10.3	MNRET Instruction .....	112
7.10.4	RNMI Operation .....	112
<b>8</b>	<b>Core-Local Interruptor (CLINT) .....</b>	<b>113</b>
8.1	CLINT Priorities and Preemption .....	113
8.2	CLINT Vector Table .....	114
8.3	CLINT Interrupt Sources .....	116
8.4	CLINT Interrupt Attribute .....	116
8.5	CLINT Memory Map .....	117
8.6	Register Descriptions .....	117
8.6.1	MSIP Registers .....	118
8.6.2	Timer Registers .....	118
<b>9</b>	<b>Platform-Level Interrupt Controller (PLIC) .....</b>	<b>119</b>
9.1	Memory Map .....	119
9.2	Interrupt Sources .....	120

9.3	Interrupt Priorities .....	121
9.4	Interrupt Pending Bits .....	121
9.5	Interrupt Enables .....	122
9.6	Priority Thresholds .....	123
9.7	Interrupt Claim Process .....	124
9.8	Interrupt Completion .....	124
9.9	Example PLIC Interrupt Handler .....	124
<b>10</b>	<b>TileLink Error Device .....</b>	<b>126</b>
<b>11</b>	<b>Power Management .....</b>	<b>127</b>
11.1	Power Modes .....	127
11.2	Run Mode .....	127
11.3	WFI Clock Gate Mode .....	127
11.3.1	WFI Wake Up .....	127
11.4	CEASE Instruction for Power Down .....	128
11.5	Hardware Reset .....	128
11.6	Early Boot Flow .....	129
11.7	Interrupt State During Early Boot .....	129
11.8	Other Boot Time Considerations .....	130
11.9	Power-Down Flow .....	130
<b>12</b>	<b>Debug .....</b>	<b>132</b>
12.1	Debug Module .....	132
12.2	Trace and Debug Registers .....	135
12.2.1	Debug Control and Status Register (dcsr) .....	137
12.2.2	Debug PC (dpc) .....	137
12.2.3	Debug Scratch (dscratch) .....	137
12.2.4	Trace and Debug Select Register (tselect) .....	138
12.2.5	Trace and Debug Data Registers (tdata1-3) .....	138
12.3	Breakpoints .....	139
12.3.1	Breakpoint Match Control Register (mcontrol) .....	139
12.3.2	Breakpoint Match Address Register (maddress) .....	141



12.3.3	Breakpoint Execution .....	141
12.3.4	Sharing Breakpoints Between Debug and Machine Mode .....	142
12.4	Debug Memory Map .....	142
12.4.1	Debug RAM and Program Buffer (0x300–0x3FF) .....	142
12.4.2	Debug ROM (0x800–0xFFF) .....	143
12.4.3	Debug Flags (0x100–0x110, 0x400–0x7FF) .....	143
12.4.4	Safe Address .....	143
12.5	Debug Module Interface .....	143
12.5.1	Debug Module Status Register (dmstatus) .....	144
12.5.2	Debug Module Control Register (dmcontrol) .....	145
12.5.3	Hart Info Register (hartinfo) .....	146
12.5.4	Abstract Control and Status Register (abstractcs) .....	148
12.5.5	Abstract Command Register (command) .....	149
12.5.6	Abstract Command Autoexec Register (abstractauto) .....	149
12.5.7	Debug Module Control and Status 2 Register (dmcs2) .....	150
12.5.8	Abstract Commands .....	150
12.5.9	System Bus Access .....	152
12.6	Debug Module Operational Sequences .....	152
12.6.1	Entering Debug Mode .....	152
12.6.2	Exiting Debug Mode .....	153
<b>A</b>	<b>SiFive Core Complex Configuration Options</b> .....	<b>154</b>
A.1	E3 Series .....	154
<b>B</b>	<b>SiFive RISC-V Implementation Registers</b> .....	<b>157</b>
B.1	Machine Architecture ID Register (marchid) .....	157
B.2	Machine Implementation ID Register (mimpid) .....	157
<b>C</b>	<b>Floating-Point Unit Instruction Timing</b> .....	<b>158</b>
C.1	E3 Floating-Point Instruction Timing .....	158
	<b>References</b> .....	<b>160</b>

# Tables

<b>Table 1</b>	E34 Core Complex Feature Set .....	15
<b>Table 2</b>	RISC-V Specification Compliance .....	19
<b>Table 3</b>	Abbreviations and Terms.....	21
<b>Table 4</b>	E3 Feature Set.....	23
<b>Table 5</b>	Executable Memory Regions for the E34 Core Complex .....	24
<b>Table 6</b>	E3 Instruction Latency .....	27
<b>Table 7</b>	pmpXcfg Bitfield Description .....	31
<b>Table 8</b>	pmpaddrX Encoding Examples for A=NAPOT.....	32
<b>Table 9</b>	mhpmevent Register.....	37
<b>Table 10</b>	Physical Memory Attributes for External Regions.....	40
<b>Table 11</b>	Physical Memory Attributes for Internal Regions.....	41
<b>Table 12</b>	E34 Core Complex Memory Map. Physical Memory Attributes: <b>R</b> –Read, <b>W</b> –Write, <b>X</b> –Execute, <b>I</b> –Instruction Cacheable, <b>D</b> –Data Cacheable, <b>A</b> –Atomics.....	42
<b>Table 13</b>	Base Instruction Formats .....	43
<b>Table 14</b>	R-Type Integer Instructions.....	45
<b>Table 15</b>	R-Type Integer Instruction Description .....	45
<b>Table 16</b>	I-Type Integer Instructions .....	46
<b>Table 17</b>	I-Type Integer Instruction Description .....	47
<b>Table 18</b>	I-Type Load Instructions .....	48
<b>Table 19</b>	I-Type Load Instruction Description .....	48
<b>Table 20</b>	S-Type Store Instructions .....	49
<b>Table 21</b>	S-Type Store Instruction Description .....	49
<b>Table 22</b>	J-Type Instruction Description.....	50
<b>Table 23</b>	B-Type Instructions.....	50
<b>Table 24</b>	B-Type Instruction Description .....	50
<b>Table 25</b>	RISC-V Base Instruction to Assembly Pseudoinstruction Example .....	51
<b>Table 26</b>	Multiplication Operation Description .....	52
<b>Table 27</b>	Division Operation Description .....	53
<b>Table 28</b>	Atomic Memory Operation Description.....	54

<b>Table 29</b>	Accrued Exception Flags.....	54
<b>Table 30</b>	Floating-Point Rounding Modes .....	55
<b>Table 31</b>	Single-Precision FP Load and Store Instructions Description .....	55
<b>Table 32</b>	Single-Precision FP Computational Instructions Description .....	56
<b>Table 33</b>	Single-Precision FP Conversion Instructions Description.....	57
<b>Table 34</b>	Single-Precision FP to FP Sign-Injection Instructions Description.....	57
<b>Table 35</b>	RISC-V Base Instruction to Assembly Pseudoinstruction Example .....	58
<b>Table 36</b>	Single-Precision FP Move Instructions Description .....	58
<b>Table 37</b>	Single-Precision FP Compare Instructions Description .....	59
<b>Table 38</b>	Single-Precision FP Classify Instruction Description .....	59
<b>Table 39</b>	Floating-Point Number Classes.....	60
<b>Table 40</b>	Stack-Pointed-Based Load Instruction Description.....	61
<b>Table 41</b>	Stack-Pointed-Based Store Instruction Description .....	62
<b>Table 42</b>	Register-Based Load Instruction Description .....	62
<b>Table 43</b>	Register-Based Store Instruction Description .....	63
<b>Table 44</b>	Unconditional Jump Instruction Description.....	63
<b>Table 45</b>	Unconditional Control Transfer Instruction Description .....	63
<b>Table 46</b>	Conditional Control Transfer Instruction Description.....	64
<b>Table 47</b>	Integer Constant-Generation Instruction Description .....	64
<b>Table 48</b>	Integer Register-Immediate Operation Description.....	65
<b>Table 49</b>	Integer Register-Immediate Operation Description (con't).....	65
<b>Table 50</b>	Integer Register-Immediate Operation Description (con't).....	65
<b>Table 51</b>	Integer Register-Immediate Operation Description (con't).....	65
<b>Table 52</b>	Integer Register-Immediate Operation Description (con't).....	66
<b>Table 53</b>	Integer Register-Register Operation Description.....	66
<b>Table 54</b>	Integer Register-Register Operation Description (con't).....	66
<b>Table 55</b>	Control and Status Register Instruction Description .....	67
<b>Table 56</b>	CSR Reads and Writes .....	68
<b>Table 57</b>	User Mode CSRs .....	69
<b>Table 58</b>	Machine Mode CSRs .....	70
<b>Table 59</b>	Debug Mode Registers .....	71
<b>Table 60</b>	Core Generator Encoding of marchid.....	72
<b>Table 61</b>	Generator Release Encoding of mimpid.....	73

<b>Table 62</b>	Timer and Counter Pseudoinstruction Description.....	74
<b>Table 63</b>	Timer and Counter CSRs .....	75
<b>Table 64</b>	RISC-V Registers .....	78
<b>Table 65</b>	RISC-V Assembly and C Examples.....	79
<b>Table 66</b>	SiFive Feature Disable CSR .....	99
<b>Table 67</b>	SiFive Feature Disable CSR Usage.....	99
<b>Table 68</b>	Exception Priority .....	101
<b>Table 69</b>	Summary of Exception and Interrupt CSRs .....	102
<b>Table 70</b>	Machine Status Register (partial) .....	105
<b>Table 71</b>	Machine Trap Vector Register.....	106
<b>Table 72</b>	Encoding of <code>mtvec.MODE</code> .....	106
<b>Table 73</b>	Machine Interrupt Enable Register .....	107
<b>Table 74</b>	Machine Interrupt Pending Register .....	107
<b>Table 75</b>	Machine Cause Register .....	108
<b>Table 76</b>	<code>mcause</code> Exception Codes.....	109
<b>Table 77</b>	RNMI CSRs .....	111
<b>Table 79</b>	E34 Core Complex Interrupt IDs .....	116
<b>Table 80</b>	CLINT Register Map .....	117
<b>Table 81</b>	PLIC Memory Map.....	120
<b>Table 82</b>	Mapping of <code>global_interrupts</code> Signal Bits to PLIC Interrupt ID .....	121
<b>Table 83</b>	PLIC Interrupt Priority Register .....	121
<b>Table 84</b>	PLIC Interrupt Pending Register 1.....	122
<b>Table 85</b>	PLIC Interrupt Pending Register 4.....	122
<b>Table 86</b>	PLIC Interrupt Enable Register 1 for Hart 0 M-Mode .....	123
<b>Table 87</b>	PLIC Interrupt Enable Register 4 for Hart 0 M-Mode .....	123
<b>Table 88</b>	PLIC Interrupt Priority Threshold Register .....	123
<b>Table 89</b>	PLIC Claim/Complete Register for Hart 0 M-Mode .....	124
<b>Table 90</b>	Debug Module Register Map Seen from the Debug Module Interface .....	133
<b>Table 91</b>	Debug Module Memory Map from the Perspective of the Core.....	134
<b>Table 92</b>	Debug Control and Status Registers .....	136
<b>Table 93</b>	Debug Control and Status Register .....	137
<b>Table 94</b>	Trace and Debug Select Register.....	138
<b>Table 95</b>	Trace and Debug Data Register 1 .....	138

<b>Table 96</b>	Trace and Debug Data Registers 2 and 3 .....	138
<b>Table 97</b>	tdata Types .....	139
<b>Table 98</b>	TDR CSRs When Used as Breakpoints .....	139
<b>Table 99</b>	Breakpoint Match Control Register .....	140
<b>Table 100</b>	NAPOT Size Encoding .....	141
<b>Table 101</b>	Debug Module Interface Signals .....	144
<b>Table 102</b>	Debug Module Status Register .....	145
<b>Table 103</b>	Debug Module Control Register .....	146
<b>Table 104</b>	Hart Info Register .....	147
<b>Table 105</b>	Abstract Control and Status Register .....	148
<b>Table 106</b>	Abstract Command Register .....	149
<b>Table 107</b>	Abstract Command Autoexec Register .....	149
<b>Table 108</b>	Debug Module Control and Status 2 Register .....	150
<b>Table 109</b>	Debug Abstract Commands .....	151
<b>Table 110</b>	Abstract Command Example for 32-bit Block Write .....	152
<b>Table 111</b>	System Bus vs. Program Buffer Comparison .....	152
<b>Table 112</b>	Core Generator Encoding of marchid .....	157
<b>Table 113</b>	Generator Release Encoding of mimpid .....	157
<b>Table 114</b>	E3 Single-Precision FPU Instruction Latency and Repeat Rates .....	159

# Figures

<b>Figure 1</b>	E3 Series Block Diagram.....	17
<b>Figure 2</b>	Example E3 Block Diagram .....	26
<b>Figure 3</b>	RV32 pmpcfg0 Register .....	30
<b>Figure 4</b>	RV32 pmpcfg1 Register .....	30
<b>Figure 5</b>	RV32 pmpcfg2 Register .....	30
<b>Figure 6</b>	RV32 pmpcfg3 Register .....	30
<b>Figure 7</b>	RV64 pmpXcfg bitfield .....	30
<b>Figure 8</b>	RV32 pmpaddrX Register.....	32
<b>Figure 9</b>	PMP Example Block Diagram .....	33
<b>Figure 10</b>	Event Selector Fields .....	36
<b>Figure 11</b>	R-Type.....	43
<b>Figure 12</b>	I-Type .....	44
<b>Figure 13</b>	S-Type.....	44
<b>Figure 14</b>	B-Type.....	44
<b>Figure 15</b>	U-Type.....	44
<b>Figure 16</b>	J-Type .....	44
<b>Figure 17</b>	ADD Instruction Example.....	45
<b>Figure 18</b>	ADDI Instruction Example.....	47
<b>Figure 19</b>	LW Instruction Example .....	48
<b>Figure 20</b>	Store Instructions.....	48
<b>Figure 21</b>	SW Instruction Example .....	49
<b>Figure 22</b>	JAL Instruction.....	49
<b>Figure 23</b>	JALR Instruction .....	49
<b>Figure 24</b>	Branch Instructions .....	50
<b>Figure 25</b>	Upper-Immediate Instructions .....	51
<b>Figure 26</b>	FENCE Instructions .....	51
<b>Figure 27</b>	NOP Instructions .....	52
<b>Figure 28</b>	Multiplication Operations .....	52
<b>Figure 29</b>	Division Operations.....	53

<b>Figure 30</b>	Atomic Memory Operations.....	53
<b>Figure 31</b>	Floating-Point Control and Status Register .....	54
<b>Figure 32</b>	Single-Precision FP Load Instruction .....	55
<b>Figure 33</b>	Single-Precision FP Store Instruction.....	55
<b>Figure 34</b>	Single-Precision FP Computational Instructions .....	56
<b>Figure 35</b>	Single-Precision FP Fused Computational Instructions.....	56
<b>Figure 36</b>	Single-Precision FP to Integer and Integer to FP Conversion Instructions .....	56
<b>Figure 37</b>	Single-Precision FP to FP Sign-Injection Instructions .....	57
<b>Figure 38</b>	Single-Precision FP Move Instructions .....	58
<b>Figure 39</b>	Single-Precision FP Compare Instructions .....	58
<b>Figure 40</b>	Single-Precision FP Classify Instruction .....	59
<b>Figure 41</b>	CR Format - Register .....	60
<b>Figure 42</b>	CI Format - Immediate .....	60
<b>Figure 43</b>	CSS Format - Stack-relative Store.....	60
<b>Figure 44</b>	CIW Format - Wide Immediate .....	60
<b>Figure 45</b>	CL Format - Load.....	61
<b>Figure 46</b>	CS Format - Store.....	61
<b>Figure 47</b>	CA Format - Arithmetic.....	61
<b>Figure 48</b>	CJ Format - Jump .....	61
<b>Figure 49</b>	Stack-Pointed-Based Loads.....	61
<b>Figure 50</b>	Stack-Pointed-Based Stores .....	61
<b>Figure 51</b>	Register-Based Loads.....	62
<b>Figure 52</b>	Register-Based Stores .....	62
<b>Figure 53</b>	Unconditional Jump Instructions.....	63
<b>Figure 54</b>	Unconditional Control Transfer Instructions .....	63
<b>Figure 55</b>	Conditional Control Transfer Instructions.....	64
<b>Figure 56</b>	Integer Constant-Generation Instructions .....	64
<b>Figure 57</b>	Integer Register-Immediate Operations.....	64
<b>Figure 58</b>	Integer Register-Immediate Operations (con't).....	65
<b>Figure 59</b>	Integer Register-Immediate Operations (con't).....	65
<b>Figure 60</b>	Integer Register-Immediate Operations (con't).....	65
<b>Figure 61</b>	Integer Register-Immediate Operations (con't).....	66
<b>Figure 62</b>	Integer Register-Register Operations.....	66

<b>Figure 63</b>	Integer Register-Register Operations (con't).....	66
<b>Figure 64</b>	Defined Illegal Instruction .....	67
<b>Figure 65</b>	Zicsr Instructions .....	67
<b>Figure 66</b>	Timer and Counter Pseudoinstructions .....	74
<b>Figure 67</b>	ECALL and EBREAK Instructions.....	76
<b>Figure 68</b>	Wait for Interrupt Instruction .....	76
<b>Figure 69</b>	RISC-V Assembly Example .....	79
<b>Figure 70</b>	RISC-V Assembly to Machine Code .....	80
<b>Figure 71</b>	One RISC-V Instruction .....	81
<b>Figure 72</b>	Stack Memory during Function Calls.....	83
<b>Figure 73</b>	RV32 Memory Layout.....	84
<b>Figure 74</b>	E34 Core Complex Interrupt Architecture Block Diagram .....	103
<b>Figure 75</b>	CLINT Block Diagram.....	113
<b>Figure 76</b>	CLINT Interrupts and Vector Table.....	114
<b>Figure 77</b>	CLINT Vector Table Example .....	115
<b>Figure 78</b>	CLINT Interrupt Attribute Example .....	117



# Chapter 1

## Introduction

SiFive's E34 Core Complex is a high performance implementation of the RISC-V RV32IMAFC architecture. The SiFive E34 Core Complex is guaranteed to be compatible with all applicable RISC-V standards, and this document should be read together with the official RISC-V user-level, privileged, and external debug architecture specifications.



A summary of features in the E34 Core Complex can be found in Table 1.

E34 Core Complex Feature Set	
Feature	Description
Number of Harts	1 Hart.
E3 Core	1 × E3 RISC-V core.
Local Interrupts	16 Local Interrupt signals per hart, which can be connected to off-core-complex devices.
PLIC Interrupts	127 Interrupt signals, which can be connected to off-core-complex devices.
PLIC Priority Levels	The PLIC supports 7 priority levels.
Hardware Breakpoints	4 hardware breakpoints.
Physical Memory Protection Unit	PMP with 8 regions and a minimum granularity of 4 bytes.

**Table 1:** E34 Core Complex Feature Set

The E34 Core Complex also has a number of on-core-complex configurability options, allowing one to tune the design to a specific application. The configurable options are described in Appendix A.

### 1.1 About this Document

This document describes the functionality of the E34 Core Complex 21G1.01.00. To learn more about the Evaluation RTL deliverables of the E34 Core Complex, consult the E34 Core Complex User Guide.

## 1.2 About this Release

This release of E34 Core Complex 21G1.01.00 is intended for evaluation purposes only. As such, the RTL source code has been intentionally obfuscated, and its use is governed by your Evaluation License.

## 1.3 E34 Core Complex Overview

The E34 Core Complex includes 1 × E3 32-bit RISC-V core, along with the necessary functional units required to support the core. These units include a Core-Local Interruptor (CLINT) to support local interrupts, a Platform-Level Interrupt Controller (PLIC) to support platform interrupts, physical memory protection, a Debug unit to support a JTAG-based debugger host connection, and a local cross-bar that integrates the various components together.

The E34 Core Complex memory system consists of a Data Tightly-Integrated Memory (DTIM) and Instruction Cache with configurable Instruction Tightly-Integrated Memory (ITIM). The E34 Core Complex also includes a Front Port, which allows external masters to be coherent with the L1 memory system and access to the TIMs, thereby removing the need to maintain coherence in software for any external agents.

An overview of the SiFive E3 Series is shown in Figure 1. Refer to the docs/core\_complex\_configuration.txt file for a comprehensive summary of the E34 Core Complex configuration.

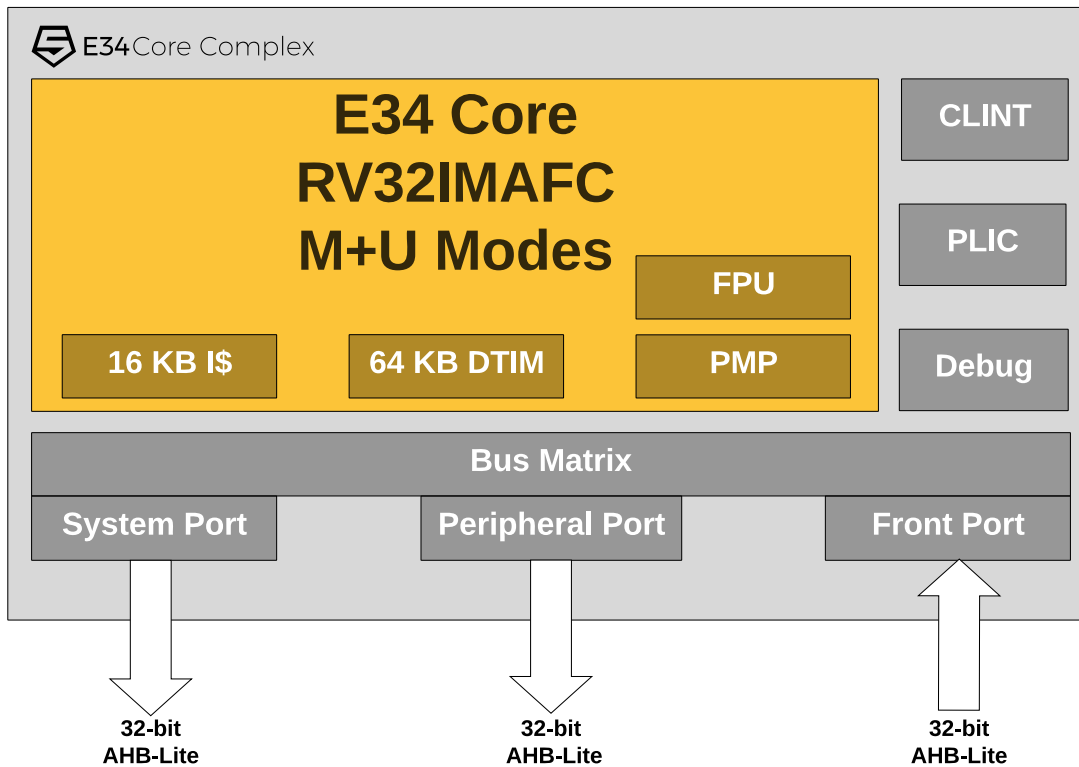

**Figure 1:** E3 Series Block Diagram

The E34 Core Complex memory map is detailed in Section 4.2, and the interfaces are described in full in the E34 Core Complex User Guide.

## 1.4 E3 RISC-V Core

The E34 Core Complex includes a 32-bit E3 RISC-V core, which has a single-issue, in-order, 5-6 stage RISC-V processor targeted for embedded applications requiring deterministic real time response. The microarchitecture is capable of delivering an IPC of 1 and the core can be clocked at relatively high clock speeds. The SiFive E3 core is guaranteed to be compatible with all applicable RISC-V standards.

The E3 core is configured to support the RV32I base ISA, as well as standard Multiply (M), Single-Precision Floating Point (F), Atomic (A), and Compressed (C) RISC-V extensions (RV32IMAFC). The E3 can also support legal combinations of privilege modes in conjunction with Physical Memory Protection (PMP), thereby allowing System-on-Chip (SoC) implementations to make the right area, power, and feature trade-offs.

The E3 core is designed to be feature rich, providing a very flexible memory system that includes a L1 cache, Tightly Integrated Memory (TIM) and standards-based configurable bus interfaces, and memory maps that provide a lot of flexibility for SoC integration. The microarchitecture also incorporates a branch prediction unit that is composed of a 28-entry Branch Target

Buffer (BTB), a 512-entry Branch History Table (BHT), and a 6-entry Return Address Stack (RAS).

The E3 includes an IEEE 754-2008 compliant Floating-Point Unit. The floating point pipeline sits in conjunction with the integer pipeline; however, it is longer, increasing the total pipeline stages to 7.

The core is described in more detail in Chapter 3.

## 1.5 Memory System

The E34 Core Complex memory system has a Level 1 memory system optimized for high performance. The instruction subsystem consists of a 16 KiB, 2-way instruction cache with the ability to reconfigure a single way into a fixed-address Instruction Tightly Integrated Memory (ITIM).

The data subsystem allows for a maximum Data Tightly Integrated Memory (DTIM) size of 64 KiB.

The memory system is described in more detail in Chapter 3.

## 1.6 Interrupts

The E34 Core Complex provides the standard RISC-V M-mode timer and software interrupts via the Core-Local Interruptor (CLINT). The Core Complex also supports 16 high-priority, low-latency local vectored interrupts per hart.

The E34 Core Complex also includes a RISC-V standard Platform-Level Interrupt Controller (PLIC), which supports 127 global interrupts with 7 priority levels.

Interrupts are described in Chapter 7. The CLINT is described in Chapter 8. The PLIC is described in Chapter 9.

## 1.7 Debug Support

The E34 Core Complex provides external debugger support over an industry-standard JTAG port, including 4 hardware-programmable breakpoints per hart.

Debug support is described in detail in Chapter 12, and the debug interface is described in the E34 Core Complex User Guide.

## 1.8 Compliance

The E34 Core Complex is compliant to the following versions of the various RISC-V specifications:

<b>ISA</b>	<b>Version</b>	<b>Ratified</b>	<b>Frozen</b>
RV32I Base Integer Instruction Set	2.0		Y
<b>Extensions</b>	<b>Version</b>	<b>Ratified</b>	<b>Frozen</b>
M Standard Extension for Integer Multiplication and Division	2.0	Y	
A Standard Extension for Atomic Instruction	2.0		Y
F Standard Extension for Single-Precision Floating-Point	2.0		Y
C Standard Extension for Compressed Instruction	2.0	Y	
<b>Privilege Mode</b>	<b>Version</b>	<b>Ratified</b>	<b>Frozen</b>
Machine-Level ISA	1.10		
User-Level ISA	1.10		
<b>Devices</b>	<b>Version</b>	<b>Ratified</b>	<b>Frozen</b>
The RISC-V Debug Specification	0.13		

**Table 2:** RISC-V Specification Compliance

## Chapter 2

# List of Abbreviations and Terms

<b>Term</b>	<b>Definition</b>
<b>AES</b>	Advanced Encryption Standard
<b>BHT</b>	Branch History Table
<b>BTB</b>	Branch Target Buffer
<b>CBC</b>	Cipher Block Chaining
<b>CCM</b>	Counter with CBC-MAC
<b>CFM</b>	Cipher FeedBack
<b>CLIC</b>	Core-Local Interrupt Controller. Configures priorities and levels for core-local interrupts.
<b>CLINT</b>	Core-Local Interruptor. Generates per hart software interrupts and timer interrupts.
<b>CTR</b>	CounTeR mode
<b>DTIM</b>	Data Tightly Integrated Memory
<b>ECB</b>	Electronic Code Book
<b>GCM</b>	Galois/Counter Mode
<b>hart</b>	HARdware Thread
<b>IJTP</b>	Indirect-Jump Target Predictor
<b>ITIM</b>	Instruction Tightly Integrated Memory
<b>JTAG</b>	Joint Test Action Group
<b>LIM</b>	Loosely-Integrated Memory. Used to describe memory space delivered in a SiFive Core Complex that is not tightly integrated to a CPU core.
<b>MDP</b>	Memory Dependence Predictor
<b>MSHR</b>	Miss Status Handling Register
<b>NLP</b>	Next-Line Predictor
<b>OFB</b>	Output FeedBack
<b>PLIC</b>	Platform-Level Interrupt Controller. The global interrupt controller in a RISC-V system.
<b>PMP</b>	Physical Memory Protection
<b>RAS</b>	Return-Address Stack
<b>RO</b>	Used to describe a Read-Only register field.
<b>ROB</b>	Reorder Buffer
<b>RW</b>	Used to describe a Read/Write register field.
<b>RW1C</b>	Used to describe a Read/Write-1-to-Clear register field.
<b>SHA</b>	Secure Hash Algorithm
<b>TileLink</b>	A free and open interconnect standard originally developed at UC Berkeley.
<b>TRNG</b>	True Random Number Generator
<b>WARL</b>	Write-Any, Read-Legal field. A register field that can be written with any value, but returns only supported values when read.
<b>WIRI</b>	Writes-Ignored, Reads-Ignore field. A read-only register field reserved for future use. Writes to the field are ignored, and reads should ignore the value returned.

**Table 3:** Abbreviations and Terms

<b>Term</b>	<b>Definition</b>
<b>WLRL</b>	Write-Legal, Read-Legal field. A register field that should only be written with legal values and that only returns legal value if last written with a legal value.
<b>WPRI</b>	Writes-Preserve, Reads-Ignore field. A register field that might contain unknown information. Reads should ignore the value returned, but writes to the whole register should preserve the original value.
<b>WO</b>	Used to describe a Write-Only registers field.
<b>W1C</b>	Used to describe a Write-1-to-Clear register field.
<b>RVV</b>	RISC-V Vector ISA.
<b>VLEN</b>	Parameter which defines the number of bits in a single vector register.
<b>SLEN</b>	Parameter which specifies the striping distance.
<b>ELEN</b>	Parameter which defines the execution length.
<b>SEW</b>	Parameter which defines the selected element width.
<b>LMUL</b>	Vector register grouping factor.
<b>DLEN</b>	Vector ALU and memory datapath width.

**Table 3:** Abbreviations and Terms



## Chapter 3

# E3 RISC-V Core

This chapter describes the 32-bit E3 RISC-V processor core, instruction fetch and execution unit, L1 memory system, Physical Memory Protection unit, Hardware Performance Monitor, and external interfaces.

The E3 feature set is summarized in Table 4.

Feature	Description
ISA	RV32IMAFC
SiFive Custom Instruction Extension (SCIE)	Not Present
Modes	Machine mode, user mode
L1 Instruction Cache	16 KiB 2-way instruction cache
Instruction Tightly-Integrated Memory (ITIM)	Shared with instruction cache (max. 8 KiB)
Data Tightly-Integrated Memory (DTIM)	64 KiB DTIM
Physical Memory Protection	8 regions with a granularity of 4 bytes.

**Table 4:** E3 Feature Set

### 3.1 Supported Modes

The E3 supports RISC-V user mode, providing two levels of privilege: machine (M) and user (U). U-mode provides a mechanism to isolate application processes from each other and from trusted code running in M-mode.

See *The RISC-V Instruction Set Manual, Volume II: Privileged Architecture, Version 1.10* for more information on the privilege modes.

### 3.2 Instruction Memory System

This section describes the instruction memory system of the E3 core.

#### 3.2.1 Execution Memory Space

The regions of executable memory consist of all directly addressable memory in the system. The memory includes any volatile or non-volatile memory located off the Core Complex ports, and includes the on-core-complex DTIM and ITIM.

Table 5 shows the executable regions of the E34 Core Complex.

Base	Top	Description
0x0180_0000	Up to 0x0180_3FFF	ITIM (optional)
0x2000_0000	0x3FFF_FFFF	Peripheral Port (512 MiB)
0x4000_0000	0x5FFF_FFFF	System Port (512 MiB)
0x8000_0000	0x8000_FFFF	DTIM (64 KiB)

**Table 5:** Executable Memory Regions for the E34 Core Complex

All executable regions, except the ITIM, are treated as instruction cacheable. There is no method to disable this behavior.

The ITIM is an optional region that repurposes a portion of the instruction cache, as described in Section 3.2.4.

Trying to execute an instruction from a non-executable address results in an instruction access trap.

### 3.2.2 L1 Instruction Cache

The L1 instruction cache is a 16 KiB 2-way set-associative cache. It has a line size of 64 bytes and is read-allocate with a random replacement policy. A cache line fill triggers a burst access outside of the Core Complex, starting with the first address of the cache line. There are no write-backs to memory from the instruction cache and it is not kept coherent with rest of the platform memory system.

Out of reset, all blocks of the instruction cache are invalidated. The access latency of the cache is one clock cycle. There is no way to disable the instruction cache and cache allocations begin immediately out of reset.

### 3.2.3 Cache Maintenance

The instruction cache supports the `FENCE.I` instruction, which invalidates the entire instruction cache, as described in Section 5.11. Writes to instruction memory from the core or another master must be synchronized with the instruction fetch stream by executing `FENCE.I`.

### 3.2.4 Instruction Cache Reconfigurability

The instruction cache can be partially reconfigured into Instruction Tightly-Integrated Memory (ITIM), which occupies a fixed address range in the memory map. ITIM provides high-performance, predictable instruction delivery. Fetching an instruction from ITIM is as fast as an instruction cache hit, with no possibility of a cache miss. ITIM can hold data as well as instructions, though loads and stores from a core to its ITIM are not as performant as loads and stores to its Data Tightly Integrated Memory (DTIM).

The ITIM region in the E34 Core Complex memory map is represented by a fixed address range that includes both the maximum range that can be allocated to ITIM, or the ITIM Mem region; as well as the remaining region that must be reserved as instruction cache, or the ITIM Ctrl region.

The instruction cache can be configured as ITIM starting from address `0x0180_0000`, in units of cache lines (64 bytes) up to a maximum size of 8 KiB, ending in address `0x0180_1FFF`. A single instruction cache way, 8 KiB, must remain an instruction cache. The ITIM is allocated simply by writing to it. A store to the  $n^{\text{th}}$  byte of the ITIM memory map reallocates the first  $n+1$  bytes of instruction cache as ITIM, rounded up to the next cache block. For determinism, software must clear the contents of ITIM after allocating it.

ITIM is deallocated by storing zero to the first byte after the maximum ITIM region, address `0x0180_2000`. The deallocated ITIM space is automatically returned to the instruction cache. Returned cache lines are invalidated. It is unpredictable whether ITIM contents are preserved between deallocation and allocation.

A hart executing in user mode can reconfigure the cache. If this is not desired, then the Physical Memory Protection unit can be used to prevent writes to the ITIM region.

Reads to the ITIM Mem region that are not allocated to the ITIM return `0x0`. Reads to the Ctrl region return unspecified data and are guaranteed not to have any side-effects. Writes to the Ctrl region beyond `0x0180_2000` have unspecified behavior and should be avoided.

### 3.2.5 Instruction Fetch Unit

The E3 instruction fetch unit is responsible for keeping the pipeline fed with instructions from memory. Fetches are always word-aligned and there is a one-cycle penalty for branching to a 32-bit instruction that is not word-aligned.

The E3 implements the standard Compressed (C) extension to the RISC-V architecture, which allows for 16-bit RISC-V instructions. As two 16-bit instructions can be fetched per cycle, the instruction fetch unit can be idle when executing programs comprised mostly of compressed 16-bit instructions. This reduces memory accesses and power consumption.

All branches must be aligned to half-word addresses. Otherwise, the fetch generates an instruction address misaligned trap. Trying to fetch from a non-executable or unimplemented address results in an instruction access trap.

### 3.2.6 Branch Prediction

The E3 instruction fetch unit contains branch prediction hardware to improve performance of the processor core. The branch predictor comprises:

- A 28-entry branch target buffer (BTB), which predicts the target of taken branches.
- A 512-entry branch history table (BHT), which predicts the direction of conditional branches.

- A 6-entry return address stack (RAS), which predicts the target of procedure returns.

Direct and indirect branches can be predicted.

The branch predictor has a one-cycle latency, such that correctly predicted control-flow instructions result in no penalty. Mispredicted control-flow instructions incur a three-cycle penalty. No maintenance can be performed on branch prediction RAMs.

Branch prediction is enabled out of reset and cannot be disabled. However, instruction speculation, fetching before a prediction is confirmed, must be enabled in the Feature Disable CSR, described in Chapter 6.

As instruction speculation can occur at any point after it has been enabled, data cacheable regions of memory (i.e., DDR) must be able to respond to instruction fetches immediately after instruction speculation is enabled. If DDR initialization is not completed before instruction speculation is enabled, the memory system must return a decode error (DECERR) for accesses made to DDR. The fetch unit will ignore errors associated with speculative accesses and continue to operate normally.

The Branch Prediction Mode CSR, also described in Chapter 6, provides a means to customize the branch predictor behavior to trade average performance for more predictable execution time.

### 3.3 Execution Pipeline

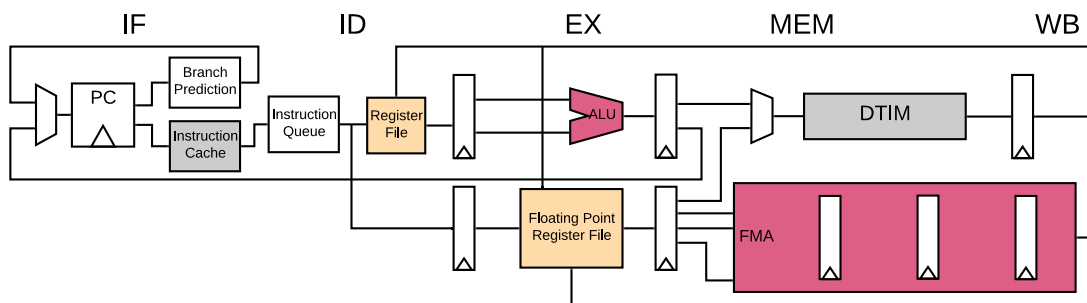

**Figure 2:** Example E3 Block Diagram

The E3 execution unit is a single-issue, in-order pipeline. The pipeline comprises five stages: instruction fetch (IF), instruction decode and register fetch (ID), execute (EX), data memory access (MEM), and register write-back (WB).

The pipeline has a peak execution rate of one instruction per clock cycle, and is fully bypassed such that most instructions have a one-cycle result latency. There are several exceptions, noted in Table 6.

Instruction	Latency
LW	Two-cycle result latency, assuming cache hit
LH, LHU, LB, LBU	Three-cycle result latency, assuming cache hit
CSR reads	Three-cycle result latency
MUL, MULH, MULHU, MULHSU	Three-cycle result latency
DIV, DIVU, REM, REMU	Between three-cycle to 35-cycle result latency, depending on operand values <sup>1</sup>
<sup>1</sup> The latency of DIV, DIVU, REM, and REMU instructions can be determined by calculating: Latency = 2 cycles + $\log_2(\text{dividend}) - \log_2(\text{divisor}) + 1$ cycle if the input is negative + 1 cycle if the output is negative	

**Table 6:** E3 Instruction Latency

The pipeline only interlocks on read-after-write and write-after-write hazards, so instructions may be scheduled to avoid stalls.

The E3 implements the standard Multiply (M) extension to the RISC-V architecture for integer multiplication and division. The E3 has a 32 bit per cycle hardware multiply and a 1 bit per cycle hardware divide. The multiplier is fully pipelined and can begin a new operation on each cycle, with a maximum throughput of one operation per cycle.

The hart will not abandon a divide instruction in flight. This means if an interrupt handler tries to use a register that is the destination register of a divide instruction, the pipeline stalls until the divide is complete.

Branch and jump instructions transfer control from the memory access pipeline stage. Correctly-predicted branches and jumps incur no penalty, whereas mispredicted branches and jumps incur a three-cycle penalty.

Most CSR writes result in a pipeline flush with a five-cycle penalty, so the results of the CSR write are observed on the next instruction.

See Appendix C for a complete list of floating-point unit instruction timings.

### 3.4 Data Memory System

The data memory system consists of on-core-complex data and the ports in the E34 Core Complex memory map, shown in Section 4.2. The on-core-complex data memory consists of a 64 KiB Data Tightly-Integrated Memory (DTIM). A design cannot have both data cache and DTIM, and the data cache is not reconfigurable like the instruction cache.

As no data cache is present, all data accesses are non-cacheable. Data accesses that are not targeted at the DTIM are also called memory-mapped I/O accesses, or MMIOs.

The E3 pipeline allows for multiple outstanding memory accesses. No store buffers are utilized in the Core Complex. The number of outstanding MMIOs are implementation dependent. Mis-aligned accesses are not allowed to any memory region and result in a trap to allow for software emulation.

### 3.4.1 Data Tightly-Integrated Memory (DTIM)

The DTIM provides deterministic access time, which is important for applications with hard real-time requirements. The access latency is two clock cycles for words and double-words, and three clock cycles for smaller quantities.

Stores are pipelined and commit on cycles where the data memory system is otherwise idle. Loads to addresses currently in the store pipeline result in a five-cycle penalty.

The DTIM region can be used to store instructions, but it has no lasting performance advantage over other memory regions. Fetching from the DTIM first results in an instruction cache line fill and execution occurs from the instruction cache.

The DTIM is capable of supporting the RISC-V standard Atomic (A) extension. Note that atomic extension support has not been configured in the E34 Core Complex.

## 3.5 Atomic Memory Operations

The E3 core supports the RISC-V standard Atomic (A) extension on the Peripheral Port and internal memory regions.

The load-reserved (LR) and store-conditional (SC) instructions are special atomic instructions that are only supported in data cacheable regions. As the E3 core does not have a data cache, the LR and SC instructions will always generate a precise access exception.

Atomic memory operations are not supported on the System Port. Atomic operations that target the System Port will generate a precise access exception.

See Section 5.4 for more information on the instructions added by this extension.

## 3.6 Floating-Point Unit (FPU)

The E3 FPU provides full hardware support for the IEEE 754-2008 floating-point standard for 32-bit single-precision arithmetic. The FPU includes a fully pipelined fused-multiply-add unit and an iterative divide and square-root unit, magnitude comparators, and float-to-integer conversion units, all with full hardware support for subnormals and all IEEE default values.

Section 5.5 describes the 32-bit single-precision instructions.

The FPU comes up disabled on reset. First initialize `fcsr` and `mstatus.FS` prior to executing any floating-point instructions. In the `freedom-meta1` startup code, write `mstatus.FS[1:0]` to `0x1`.

## 3.7 Local Interrupts

The E3 supports up to 16 local interrupt sources that are routed directly to the core. See Chapter 7 for a detailed description of Local Interrupts.

## 3.8 Physical Memory Protection (PMP)

Machine mode is the highest privilege level and by default has read, write, and execute permissions across the entire memory map of the device. However, privilege levels below machine mode do not have read, write, or execute permissions to any region of the device memory map unless it is specifically allowed by the PMP. For the lower privilege levels, the PMP may grant permissions to specific regions of the device's memory map, but it can also revoke permissions when in machine mode.

When programmed accordingly, the PMP will check every access when the hart is operating in user mode. For machine mode, PMP checks do not occur unless the lock bit (L) is set in the `pmpcfgY` CSR for a particular region.

PMP checks also occur on loads and stores when the machine previous privilege level is user (`mstatus.MPP=0x0`), and the Modify Privilege bit is set (`mstatus.MPRV=1`). For virtual address translation, PMP checks are also applied to page table accesses in supervisor mode.

The E3 PMP supports 8 regions with a minimum region size of 4 bytes.

This section describes how PMP concepts in the RISC-V architecture apply to the E3. For additional information on the PMP refer to *The RISC-V Instruction Set Manual, Volume II: Privileged Architecture, Version 1.10*.

### 3.8.1 PMP Functional Description

The E3 PMP unit has 8 regions and a minimum granularity of 4 bytes. Access to each region is controlled by an 8-bit `pmpXcfg` field and a corresponding `pmpaddrX` register. Overlapping regions are permitted, where the lower numbered `pmpXcfg` and `pmpaddrX` registers take priority over higher numbered regions. The E3 PMP unit implements the architecturally defined `pmpcfgY` CSRs `pmpcfg0` and `pmpcfg1`, supporting 8 regions. `pmpcfg2` and `pmpcfg3` are implemented, but hardwired to zero.

The PMP registers may only be programmed in M-mode. Ordinarily, the PMP unit enforces permissions on U-mode accesses. However, locked regions (see Section 3.8.2) additionally enforce their permissions on M-mode.

### 3.8.2 PMP Region Locking

The PMP allows for region locking whereby, once a region is locked, further writes to the configuration and address registers are ignored. Locked PMP entries may only be unlocked with a system reset. A region may be locked by setting the L bit in the pmpXcfg register.

In addition to locking the PMP entry, the L bit indicates whether the R/W/X permissions are enforced on machine mode accesses. When the L bit is clear, the R/W/X permissions apply only to U-mode.

### 3.8.3 PMP Registers

Each PMP region is described by an 8-bit pmpXcfg field, used in association with a 32-bit pmpaddrX register that holds the base address of the protected region. The range of each region depends on the Addressing (A) mode described in the next section. The pmpXcfg fields reside within 32-bit pmpcfgY CSRs.

Each 8-bit pmpXcfg field includes a read, write, and execute bit, plus a two bit address-matching field A, and a Lock bit, L. Overlapping regions are permitted, where the lowest numbered PMP entry wins for that region.

#### PMP Configuration Registers

The pmpcfgY CSRs are shown below for a 32-bit design.

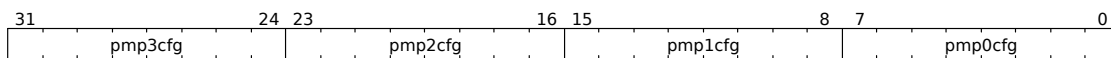

Figure 3: RV32 pmpcfg0 Register

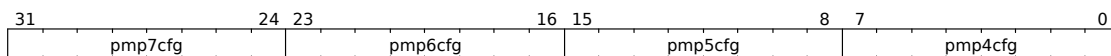

Figure 4: RV32 pmpcfg1 Register

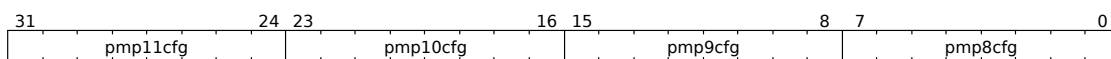

Figure 5: RV32 pmpcfg2 Register

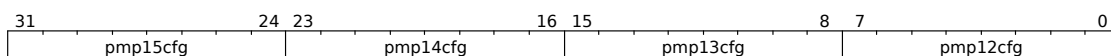

Figure 6: RV32 pmpcfg3 Register

The pmpcfgY and pmpaddrX registers are only accessible via CSR specific instructions such as csrr for reads, and csrw for writes.

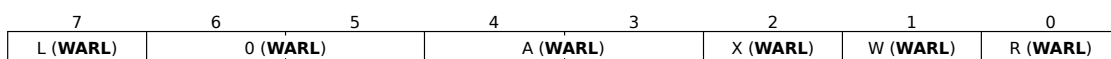

Figure 7: RV64 pmpXcfg bitfield



Bits	Description
0	<b>R: Read Permissions</b> <ul style="list-style-type: none"> <li>• 0x0 - No read permissions for this region</li> <li>• 0x1 - Read permission granted for this region</li> </ul>
1	<b>W: Write Permissions</b> <ul style="list-style-type: none"> <li>• 0x0 - No write permissions for this region</li> <li>• 0x1 - Write permission granted for this region</li> </ul>
2	<b>X: Execute permissions</b> <ul style="list-style-type: none"> <li>• 0x0 - No execute permissions for this region</li> <li>• 0x1 - Execute permission granted for this region</li> </ul>
[4:3]	<b>A: Address matching mode</b> <ul style="list-style-type: none"> <li>• 0x0 - PMP Entry disabled. No PMP protection applied for any privilege level.</li> <li>• 0x1 - Top of range (TOR) region defined by two adjacent pmpaddr registers. The upper limit of region X is defined by pmpaddrX, and the base of the region is defined by pmpaddr(X-1). Address 'a' matches the region if <math>[pmpaddr(X-1) \leq a &lt; pmpaddrX]</math>. If pmp0cfg defines a TOR region, then the base address of that region is 0x0, and pmpaddr0 defines the upper limit. Supports only a four byte granularity.</li> <li>• 0x2 - Naturally aligned four-byte region (NA4). Supports only a four-byte region with four byte granularity.</li> <li>• 0x3 - Naturally aligned power-of-two region (NAPOT), <math>\geq 8</math> bytes. When this setting is programmed, the low bits of the pmpaddrX register encode the size, while the upper bits encode the base address right shifted by two. There is a zero bit in between, we will refer to as the least significant zero bit (LSZB).</li> </ul>
7	<b>L: Lock Bit</b> <ul style="list-style-type: none"> <li>• 0x0 - PMP Entry Unlocked, no permission restrictions applied to machine mode. PMP entry only applies to S and U modes.</li> <li>• 0x1 - PMP Entry Locked, permissions enforced for all privilege levels including machine mode. Writes to pmpXcfg and pmpcfgY are ignored and can only be cleared with system reset.</li> </ul>
<b>Note:</b> The combination of R=0 and W=1 is not currently implemented.	

**Table 7:** pmpXcfg Bitfield Description

Out of reset, the PMP register fields A and L are set to 0. All other hart state is unspecified by *The RISC-V Instruction Set Manual, Volume II: Privileged Architecture, Version 1.10*.

Some examples follow using NAPOT address mode.

Base Address	Region Size*	LSZB Position	pmpaddrX Value
0x4000_0000	8 B	0	(0x1000_0000   1'b0)
0x4000_0000	32 B	2	(0x1000_0000   3'b011)
0x4000_0000	4 KB	9	(0x1000_0000   10'b01_1111_1111)
0x4000_0000	64 KB	13	(0x1000_0000   14'b01_1111_1111_1111)
0x4000_0000	1 MB	17	(0x1000_0000   18'b01_1111_1111_1111_1111)
*Region size is $2^{(LSZB+3)}$ .			

**Table 8:** pmpaddrX Encoding Examples for A=NAPOT

### PMP Address Registers

The PMP has 8 address registers. Each address register pmpaddrX correlates to the respective pmpXcfg field. Each address register contains the base address of the protected region right shifted by two, for a minimum 4-byte alignment.

The maximum encoded address bits per *The RISC-V Instruction Set Manual, Volume II: Privileged Architecture, Version 1.10* are [33:2].

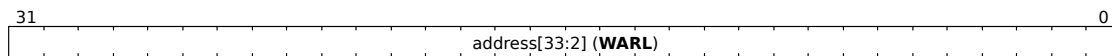

**Figure 8:** RV32 pmpaddrX Register

### 3.8.4 PMP and PMA

The PMP values are used in conjunction with the Physical Memory Attributes (PMAs) described in Section 4.1. Since the PMAs are static and not configurable, the PMP can only revoke read, write, or execute permissions to the PMA regions if those permissions already apply statically.

### 3.8.5 PMP Programming Overview

The PMP registers can only be programmed in machine mode. The pmpaddrX register should be first programmed with the base address of the protected region, right shifted by two. Then, the pmpcfgY register should be programmed with the properly configured 32-bit value containing each properly aligned 8-bit pmpXcfg field. Fields that are not used can be simply written to 0, marking them unused.

### PMP Programming Example

The following example shows a machine mode only configuration where PMP permissions are applied to three regions of interest, and a fourth region covers the remaining memory map. Recall that lower numbered pmpXcfg and pmpaddrX registers take priority over higher numbered regions. This rule allows higher numbered PMP registers to have blanket coverage over the entire memory map while allowing lower numbered regions to apply permissions to specific regions of interest. The following example shows a 64 KB Flash region at base address 0x0, a

32 KB RAM region at base address 0x2000\_0000, and finally a 4 KB peripheral region at base address base 0x3000\_0000. The rest of the memory map is reserved space.

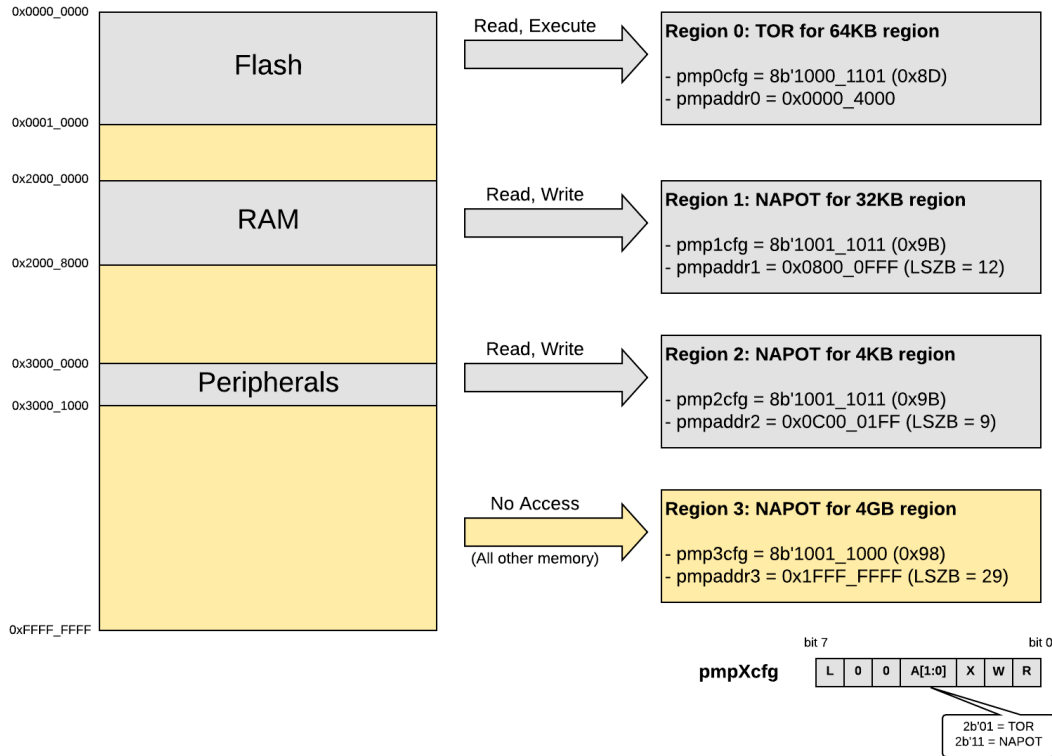

Figure 9: PMP Example Block Diagram

### PMP Access Scenarios

The L, R, W, and X bits only determine if an access succeeds if all bytes of that access are covered by that PMP entry. For example, if a PMP entry is configured to match the four-byte range 0xC–0xF, then an 8-byte access to the range 0x8–0xF will fail, assuming that PMP entry is the highest-priority entry that matches those addresses.

While operating in machine mode when the lock bit is clear (L=0), if a PMP entry matches all bytes of an access, the access succeeds. If the lock bit is set (L=1) while in machine mode, then the access depends on the permissions set for that region. Similarly, while in Supervisor mode, the access depends on permissions set for that region.

Failed read or write accesses generate a load or store access exception, and an instruction access fault would occur on a failed instruction fetch. When an exception occurs while attempting to execute from a region without execute permissions, the fault occurs on the fetch and not the branch, so the mepc CSR will reflect the value of the targeted protected region, and not the address of the branch.

It is possible for a single instruction to generate multiple accesses, which may not be mutually atomic. If at least one access generated by an instruction fails, then an exception will occur. It might be possible that other accesses from a single instruction will succeed, with visible side effects. For example, references to virtual memory may be decomposed into multiple accesses.

On some implementations, misaligned loads, stores, and instruction fetches may also be decomposed into multiple accesses, some of which may succeed before an access exception occurs. In particular, a portion of a misaligned store that passes the PMP check may become visible, even if another portion fails the PMP check. The same behavior may manifest for floating-point stores wider than XLEN bits (e.g., the FSD instruction in RV32D), even when the store address is naturally aligned.

### 3.8.6 PMP and Paging

The Physical Memory Protection mechanism is designed to compose with the page-based virtual memory systems described in *The RISC-V Instruction Set Manual, Volume II: Privileged Architecture, Version 1.10*. When paging is enabled, instructions that access virtual memory may result in multiple physical-memory accesses, including implicit references to the page tables. The PMP checks apply to all of these accesses. The effective privilege mode for implicit page-table accesses is supervisor mode.

Implementations with virtual memory are permitted to perform address translations speculatively and earlier than required by an explicit virtual-memory access. The PMP settings for the resulting physical address may be checked at any point between the address translation and the explicit virtual-memory access. A mis-predicted branch to a non-executable address range does not generate a trap. Hence, when the PMP settings are modified in a manner that affects either the physical memory that holds the page tables or the physical memory to which the page tables point, M-mode software must synchronize the PMP settings with the virtual memory system. This is accomplished by executing an SFENCE.VMA instruction with  $rs1=x0$  and  $rs2=x0$ , after the PMP CSRs are written.

If page-based virtual memory is not implemented, or when it is disabled, memory accesses check the PMP settings synchronously, so no fence is needed.

### 3.8.7 PMP Limitations

In a system containing multiple harts, each hart has its own PMP device. The PMP permissions on a hart cannot be applied to accesses from other harts in a multi-hart system. In addition, SiFive designs may contain a Front Port to allow external bus masters access to the full memory map of the system. The PMP cannot prevent access from external bus masters on the Front Port.

### 3.8.8 Behavior for Regions without PMP Protection

If a non-reserved region of the memory map does not have PMP permissions applied, then by default, supervisor or user mode accesses will fail, while machine mode access will be allowed.

Access to reserved regions within a device's memory map (an interrupt controller for example) will return 0x0 on reads, and writes will be ignored. Access to reserved regions outside of a device's memory map without PMP protection will result in a bus error.

### 3.8.9 Cache Flush Behavior on PMP Protected Region

When a line is brought into cache and the PMP is set up with the lock (L) bit asserted to protect a part of that line, a data cache flush instruction will generate a store access fault exception if the flush includes any part of the line that is protected. The cache flush instruction does an invalidate and write-back, so it is essentially trying to write back to the memory location that is protected. If a cache flush occurs on a part of the line that was not protected, the flush will succeed and not generate an exception. If a data cache flush is required without a write-back, use the cache discard instruction instead, as this will invalidate but not write back the line.

## 3.9 Hardware Performance Monitor

The E3 processor core supports a basic hardware performance monitoring (HPM) facility. The performance monitoring facility is divided into two classes of counters: fixed-function and event-programmable counters. These classes consist of a set of fixed counters and their counter-enable registers, as well as a set of event-programmable counters and their event selector registers. The registers are available to control the behavior of the counters. Performance monitoring can be useful for multiple purposes, from optimization to debug.

### 3.9.1 Performance Monitoring Counters Reset Behavior

The `instret` and `cycle` counters are initialized to zero on system reset. The hardware performance monitor event counters are not initialized on system reset, and thus have an arbitrary value. Users can write desired values to the counter control and status registers (CSRs) to start counting at a given, known value.

### 3.9.2 Fixed-Function Performance Monitoring Counters

A fixed-function performance monitor counter is hardware wired to only count one specific event type. That is, they cannot be reconfigured with respect to the event type(s) they count. The only modification to the fixed-function performance monitoring counters that can be done is to enable or disable counting, and write the counter value itself.

The E3 processor core contains two fixed-function performance monitoring counters.

#### Fixed-Function Cycle Counter (`mcycle`)

The fixed-function performance monitoring counter `mcycle` holds a count of the number of clock cycles the hart has executed since some arbitrary time in the past. The `mcycle` counter is read-write and 64 bits wide. Reads of `mcycle` return the lower 32 bits, while reads of `mcycleh` return the upper 32 bits of the 64-bit `mcycle` counter.

### Fixed-Function Instructions-Retired Counter (`minstret`)

The fixed-function performance monitoring counter `minstret` holds a count of the number of instructions the hart has retired since some arbitrary time in the past. The `minstret` counter is read-write and 64 bits wide. Reads of `minstret` return the lower 32 bits, while reads of `minstreth` return the upper 32 bits of the 64-bit `minstret` counter.

### 3.9.3 Event-Programmable Performance Monitoring Counters

Complementing the fixed-function counters are a set of programmable event counters. The E3 HPM includes two additional event counters, `mhpmcounter3` and `mhpmcounter4`. These programmable event counters are read-write and 64 bits wide. Reads of any of `mhpmcounter3h` or `mhpmcounter4h` return the upper 32 bits of their corresponding machine performance-monitoring counter. The hardware counters themselves are implemented as 40-bit counters on the E3 core series. These hardware counters can be written to in order to initialize the counter value.

### 3.9.4 Event Selector Registers

To control the event type to count, event selector CSRs `mhpmevent3` and `mhpmevent4` are used to program the corresponding event counters. These event selector CSRs are 32-bit **WARL** registers.

The event selectors are partitioned into two fields; the lower 8 bits select an event class, and the upper bits form a mask of events in that class.

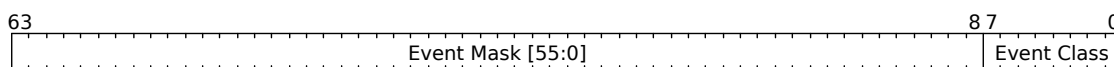

**Figure 10:** Event Selector Fields

The counter increments if the event corresponding to any set mask bit occurs. For example, if `mhpmevent3` is set to `0x4200`, then `mhpmcounter3` will increment when either a load instruction or a conditional branch instruction retires. An event selector of 0 means "count nothing".

### 3.9.5 Event Selector Encodings

Table 9 describes the event selector encodings available. Events are categorized into classes based on the Event Class field encoded in `mhpmeventX[7:0]`. One or more events can be programmed by setting the respective Event Mask bit for a given event class. An event selector encoding of 0 means "count nothing". Multiple events will cause the counter to increment any time any of the selected events occur.

<b>Machine Hardware Performance Monitor Event Register</b>	
Instruction Commit Events, mhpmeventX[7:0]=0x0	
<b>Bits</b>	<b>Description</b>
8	Exception taken
9	Integer load instruction retired
10	Integer store instruction retired
11	Atomic memory operation retired
12	System instruction retired
13	Integer arithmetic instruction retired
14	Conditional branch retired
15	JAL instruction retired
16	JALR instruction retired
17	Integer multiplication instruction retired
18	Integer division instruction retired
19	Floating-point load instruction retired
20	Floating-point store instruction retired
21	Floating-point addition retired
22	Floating-point multiplication retired
23	Floating-point fused multiply-add retired
24	Floating-point division or square-root retired
25	Other floating-point instruction retired
Microarchitectural Events, mhpmeventX[7:0]=0x1	
<b>Bits</b>	<b>Description</b>
8	Load-use interlock
9	Long-latency interlock
10	CSR read interlock
11	Instruction cache/ITIM busy
12	Data cache/DTIM busy
13	Branch direction misprediction
14	Branch/jump target misprediction
15	Pipeline flush from CSR write
16	Pipeline flush from other event
17	Integer multiplication interlock
18	Floating-point interlock
Memory System Events, mhpmeventX[7:0]=0x2	
<b>Bits</b>	<b>Description</b>
8	Instruction cache miss
9	Memory-mapped I/O access

**Table 9:** mhpmevent Register

Event mask bits that are writable for any event class are writable for all classes. Setting an event mask bit that does not correspond to an event defined in Table 9 has no effect for current implementations. However, future implementations may define new events in that encoding space, so it is not recommended to program unsupported values into the mhpmevent registers.

## Combining Events

It is common usage to directly count each respective event. Additionally, it is possible to use combinations of these events to count new, unique events. For example, to determine the average cycles per load from a data memory subsystem, program one counter to count "Data cache/DTIM busy" and another counter to count "Integer load instruction retired". Then, simply divide the "Data cache/DTIM busy" cycle count by the "Integer load instruction retired" instruction count and the result is the average cycle time for loads in cycles per instruction.

It is important to be cognizant of the event types being combined; specifically, event types counting occurrences and event types counting cycles.

### 3.9.6 Counter-Enable Registers

The 32-bit counter-enable register `mcounteren` controls the availability of the hardware performance-monitoring counters to the next-lowest privileged mode.

The settings in these registers only control accessibility. The act of reading or writing these enable registers does not affect the underlying counters, which continue to increment when not accessible.

When any bit in the `mcounteren` register is clear, attempts to read the cycle, time, instruction retire, or `hpmcounterX` register while executing in U-mode will cause an illegal instruction exception. When one of these bits is set, access to the corresponding register is permitted in the next implemented privilege mode, U-mode.

`mcounteren` is a **WARL** register. Any of the bits may contain a hardwired value of zero, indicating reads to the corresponding counter will cause an illegal instruction exception when executing in a less-privileged mode.

## 3.10 Ports

This section describes the Port interfaces to the E3 core.

### 3.10.1 Front Port

The Front Port can be used by external masters to read from and write into the memory system utilizing any port in the Core Complex. The ITIM and DTIM can also be accessed through the Front Port.

Accesses from external masters through the Front Port have the same latency to either ITIM or DTIM, as Front Port instruction fetches are considered reads. In other words, code execution or data accesses to either ITIM or DTIM will have the same cycle count. Internal arbitration prioritizes access from the local hart over Front Port accesses, in the event that they happen at the same time.



The E34 Core Complex User Guide describes the implementation details of the Front Port.

**Note**

Logic in the core prevents non-debug-mode code from accessing the debug region. However, this logic does not intercept accesses from the Front Port. This means that it is possible for Front Port accesses to interfere with a debug session by writing to various offsets within the debug region. To work around this, do not access the debug module memory region via the Front Port.

### 3.10.2 Peripheral Port

The Peripheral Port is used to interface with lower speed peripherals and also supports code execution. When a device is attached to the Peripheral Port, it is expected that there are no other masters connected to that device.

Consult Section 4.1 for further information about the Peripheral Port and its Physical Memory Attributes.

See the E34 Core Complex User Guide for a description of the Peripheral Port implementation in the E34 Core Complex.

### 3.10.3 System Port

The System Port is used to interface with lower performance memory, like SRAM, memory-mapped I/O (MMIO), and higher speed peripherals. The System Port also supports code execution.

Consult Section 4.1 for further information about the System Port and its Physical Memory Attributes.

See the E34 Core Complex User Guide for a description of the System Port implementation in the E34 Core Complex.

## Chapter 4

# Physical Memory Attributes and Memory Map

This chapter describes the E34 Core Complex physical memory attributes and memory map.

### 4.1 Physical Memory Attributes Overview

The memory map is divided into different regions covering on-core-complex memory, system memory, peripherals, and empty holes. Physical memory attributes (PMAs) describe the properties of the accesses that can be made to each region in the memory map. These properties encompass the type of access that may be performed: execute, read, or write. As well as other optional attributes related to the access, such as supported access size, alignment, atomic operations, and cacheability.

RISC-V utilizes a simpler approach than other processor architectures in defining the attributes of memory accesses. Instead of defining access characteristics in page table descriptors or memory protection logic, the properties are fixed for memory regions or may only be modified in platform-specific control registers. As most systems don't require the ability to modify PMAs, SiFive cores only support fixed PMAs, which are set at design time. This results in a simpler design with lower gate count and power savings, and an easier programming interface.

External memory map regions are accessed through a specific port type and that port type is used to define the PMAs. The port types are Memory, Peripheral, and System. Memory map regions defined for internal memory and internal control regions also have a predefined PMA based on the underlying contents of the region.

The assigned PMA properties and attributes for E34 Core Complex memory regions are shown in Table 10 and Table 11 for external and internal regions, respectively.

The configured memory regions of the E34 Core Complex are listed with their attributes in Table 12.

Port Type	Access Properties	Attributes
Peripheral Port	Read, Write, Execute	Atomics, Instruction Cacheable
System Port	Read, Write, Execute	Instruction Cacheable

**Table 10:** Physical Memory Attributes for External Regions

Region	Access Properties	Attributes
CLINT	Read, Write	Atomics
DTIM	Read, Write, Execute	Atomics
Debug	None	N/A
Error Device	Read, Write, Execute	Atomics
ITIM	Read, Write, Execute	Atomics, Instruction Speculation
PLIC	Read, Write	Atomics
Reserved	None	N/A

**Table 11:** Physical Memory Attributes for Internal Regions

All memory map regions support word, half-word, and byte size data accesses.

Atomic access support enables the RISC-V standard Atomic (A) Extension for atomic instructions. These atomic instructions are further documented in Section 3.5 for the E3 core.

No region supports unaligned accesses. An unaligned access will generate the appropriate trap: instruction address misaligned, load address misaligned, or store/AMO address misaligned.

The Physical Memory Protection unit is capable of controlling access properties based on address ranges, not ports. It has no control over the attributes of an address range, however.

**Note**

The Debug and Error Device regions have special behavior. The Debug region is reserved for use from a Debugger, and all accesses to it from the core in non-Debug mode will trap. The Error Device will also trap all accesses, as described in Chapter 10.

## 4.2 Memory Map

The memory map of the E34 Core Complex is shown in Table 12.

Base	Top	PMA	Description
0x0000_0000	0x0000_0FFF		Debug
0x0000_1000	0x0000_2FFF		Reserved
0x0000_3000	0x0000_3FFF	RWX A	Error Device
0x0000_4000	0x017F_FFFF		Reserved
0x0180_0000	0x0180_3FFF	RWX A	ITIM
0x0180_4000	0x01FF_FFFF		Reserved
0x0200_0000	0x0200_FFFF	RW A	CLINT
0x0201_0000	0x0BFF_FFFF		Reserved
0x0C00_0000	0x0C3F_FFFF	RW A	PLIC
0x0C40_0000	0x1FFF_FFFF		Reserved
0x2000_0000	0x3FFF_FFFF	RWXI A	Peripheral Port (512 MiB)
0x4000_0000	0x5FFF_FFFF	RWXI	System Port (512 MiB)
0x6000_0000	0x7FFF_FFFF		Reserved
0x8000_0000	0x8000_FFFF	RWX A	DTIM (64 KiB)
0x8001_0000	0xFFFF_FFFF		Reserved

**Table 12:** E34 Core Complex Memory Map. Physical Memory Attributes: **R**–Read, **W**–Write, **X**–Execute, **I**–Instruction Cacheable, **D**–Data Cacheable, **A**–Atomics

## Chapter 5

# Programmer's Model

The E34 Core Complex implements the 32-bit RISC-V architecture. The following chapter provides a reference for programmers and an explanation of the extensions supported by RV32IMAFIC.

This chapter contains a high-level discussion of the RISC-V instruction set architecture and additional resources which will assist software developers working with RISC-V products. The E34 Core Complex is an implementation of the RISC-V RV32IMAFIC architecture, and is guaranteed to be compatible with all applicable RISC-V standards. RV32IMAFIC can emulate almost any other RISC-V ISA extension.

### 5.1 Base Instruction Formats

RISC-V base instructions are fixed to 32 bits in length and must be aligned on a four-byte boundary in memory. RISC-V ISA keeps the source (*rs1* and *rs2*) and destination (*rd*) registers at the same position in all formats to simplify decoding, with the exception of the 5-bit immediates used in CSR instructions.

The various formats are described in Table 13 below.

Format	Description
R	Format for register-register arithmetic/logical operations.
I	Format for register-immediate ALU operations and loads.
S	Format for stores.
B	Format for branches.
U	Format for 20-bit upper immediate instructions.
J	Format for jumps.

**Table 13:** Base Instruction Formats

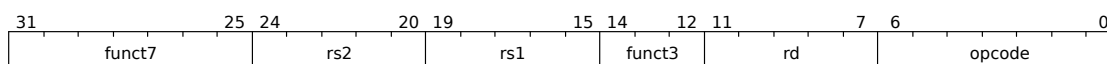

**Figure 11:** R-Type

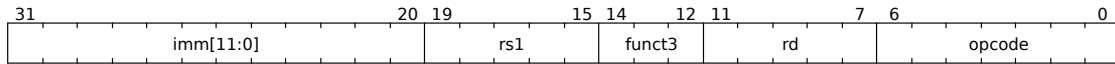

Figure 12: I-Type

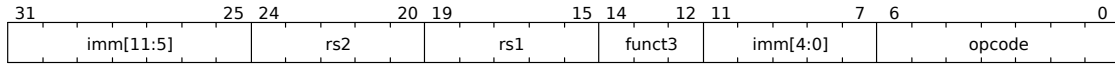

Figure 13: S-Type

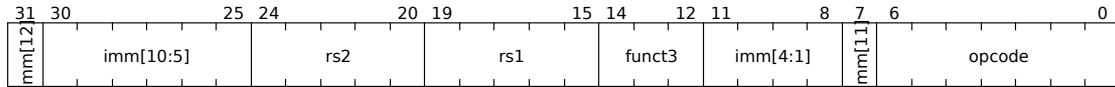

Figure 14: B-Type

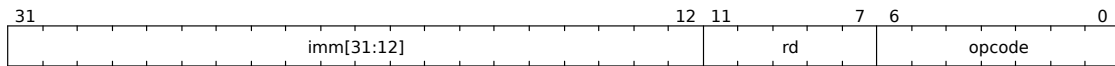

Figure 15: U-Type

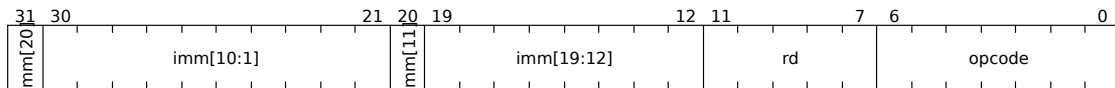

Figure 16: J-Type

The **opcode** field partially specifies an instruction, combined with **funct7 + funct3** which describe what operation to perform. Each register field (**rs1**, **rs2**, **rd**) holds a 5-bit unsigned integer (0-31) corresponding to a register number (x0 - x31). Sign-extension is one of the most critical operations on immediates (particularly for XLEN>32), and in RISC-V the sign bit for all immediates is always held in bit 31 of the instruction to allow sign-extension to proceed in parallel with instruction decoding.

## 5.2 I Extension: Standard Integer Instructions

This section discusses the standard integer instructions supported by RISC-V. Integer computational instructions don't cause arithmetic exceptions.

### 5.2.1 R-Type (Register-Based) Integer Instructions

funct7			funct3		opcode	Instruction
00000000	rs2	rs1	000	rd	0110011	ADD
01000000	rs2	rs1	000	rd	0110011	SUB
00000000	rs2	rs1	001	rd	0110011	SLL
00000000	rs2	rs1	010	rd	0110011	SLT
00000000	rs2	rs1	011	rd	0110011	SLTU
00000000	rs2	rs1	100	rd	0110011	XOR
00000000	rs2	rs1	101	rd	0110011	SRL
01000000	rs2	rs1	101	rd	0110011	SRA
00000000	rs2	rs1	110	rd	0110011	OR
00000000	rs2	rs1	111	rd	0110011	AND

**Table 14:** R-Type Integer Instructions

Instruction	Description
ADD rd, rs1, rs2	Performs the addition of rs1 and rs2, result stored in rd.
SUB rd, rs1, rs2	Performs the subtraction of rs2 from rs1, result stored in rd.
SLL rd, rs1, rs2	Logical left shift (zeros are shifted into the lower bits) shift amount is encoded in the lower 5 bits of rs2.
SLT rd, x0, rs2	Signed and compare sets rd to 1 if rs2 is not equal to zero, otherwise sets rd to zero.
SLTU rd, x0, rs2	Unsigned compare sets rd to 1 if rs2 is not equal to zero, otherwise sets rd to zero.
SRL rd, rs1, rs2	Logical right shift (zeros are shifted into the lower bits) shift amount is encoded in the lower 5 bits of rs2.
SRA rd, rs1, rs2	Arithmetic right shift, shift amount is encoded in the lower 5 bits of rs2.
OR rd, rs1, rs2	Bitwise logical OR.
AND rd, rs1, rs2	Bitwise logical AND.
XOR rd, rs1, rs2	Bitwise logical XOR.

**Table 15:** R-Type Integer Instruction Description

Below is an example of an ADD instruction.

**add x18, x19, x10**

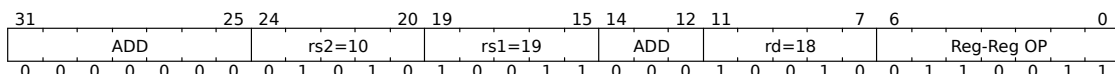

**Figure 17:** ADD Instruction Example

## 5.2.2 I-Type Integer Instructions

For I-Type integer instruction, one field is different from R-format. `rs2` and `funct7` are replaced by the 12-bit signed immediate, `imm[11:0]`, which can hold values in range `[-2048, +2047]`. The immediate is always sign-extended to 32-bits before being used in an arithmetic operation. Bits `[31:12]` receive the same value as bit 11.

imm			func3		opcode	Instruction
imm[11:0]		rs1	000	rd	0010011	ADDI
imm[11:0]		rs1	010	rd	0010011	SLTI
imm[11:0]		rs1	011	rd	0010011	SLTIU
imm[11:0]		rs1	100	rd	0010011	XORI
imm[11:0]		rs1	110	rd	0010011	ORI
imm[11:0]		rs1	111	rd	0010011	ANDI
00000000	shamnt	rs1	001	rd	0010011	SLLI
00000000	shamnt	rs1	101	rd	0010011	SRLI
01000000	shamnt	rs1	001	rd	0010011	SRAI

**Table 16:** I-Type Integer Instructions

One of the higher-order immediate bits is used to distinguish "shift right logical" (SRLI) from "shift right arithmetic" (SRAI).



Instruction	Description
ADDI	Adds the sign-extended 12-bit immediate to register <i>rs1</i> . Arithmetic overflow is ignored and the result is simply the low 32-bits of the result. <code>ADDI rd, rs1, 0</code> is used to implement the <code>MV rd, rs1</code> assembler pseudoinstruction.
SLTI	Set less than immediate. Places the value 1 in register <i>rd</i> if register <i>rs1</i> is less than the sign extended immediate when both are treated as signed numbers, else 0 is written to <i>rd</i> .
SLTIU	Compares the values as unsigned numbers (i.e., the immediate is first sign-extended to 32-bits then treated as an unsigned number). Note: <code>SLTIU rd, rs1, 1</code> sets <i>rd</i> to 1 if <i>rs1</i> equals zero, otherwise sets <i>rd</i> to 0 (assembler pseudo instruction <code>SEQZ rd, rs</code> ).
XORI	Bitwise XOR on register <i>rs1</i> and the sign-extended 12-bit immediate and place the result in <i>rd</i> .
ORI	Bitwise OR on register <i>rs1</i> and the sign-extended 12-bit immediate and place the result in <i>rd</i> .
ANDI	Bitwise AND on register <i>rs1</i> and the sign-extended 12-bit immediate and place the result in <i>rd</i> .
SLLI	Shift Left Logical. The operand to be shifted is in <i>rs1</i> , and the shift amount is encoded in the lower 5 bits of the I-immediate field.
SRLI	Shift Right Logical. The operand to be shifted is in <i>rs1</i> , and the shift amount is encoded in the lower 5 bits of the I-immediate field.
SRAI	Shift Right Arithmetic. The operand to be shifted is in <i>rs1</i> , and the shift amount is encoded in the lower 5 bits of the I-immediate field (the original sign bit is copied into the vacated upper bits).

**Table 17:** I-Type Integer Instruction Description

Shift-by-immediate instructions only use lower 5 bits of the immediate value for shift amount (can only shift by 0-31 bit positions).

Below is an example of an ADDI instruction.

**addi x15, x1, -50**

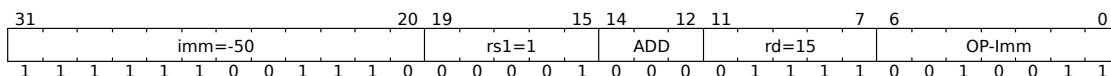

**Figure 18:** ADDI Instruction Example

### 5.2.3 I-Type Load Instructions

For I-Type load instructions, a 12-bit signed immediate is added to the base address in register *rs1* to form the memory address. In Table 18 below, **funct3** field encodes size and signedness of load data.

imm		func3		opcode	Instruction
imm[11:0]	rs1	000	rd	00000011	LB
imm[11:0]	rs1	001	rd	00000011	LH
imm[11:0]	rs1	010	rd	00000011	LW
imm[11:0]	rs1	100	rd	00000011	LBU
imm[11:0]	rs1	101	rd	00000011	LHU

**Table 18:** I-Type Load Instructions

Instruction	Description
LB rd, rs1, imm	Load Byte, loads 8 bits (1 byte) and sign-extends to fill destination 32-bit register.
LH rd, rs1, imm	Load Half-Word. Loads 16 bits (2 bytes) and sign-extends to fill destination 32-bit register.
LW rd, rs1, imm	Load Word, 32 bits.
LBU rd, rs1, imm	Load Unsigned Byte (8-bit).
LHU rd, rs1, imm	Load Unsigned Half-Word, which zero-extends 16 bits to fill destination 32-bit register.

**Table 19:** I-Type Load Instruction Description

Below is an example of a LW instruction.

**lw x14, 8(x2)**

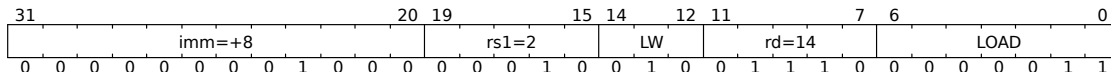

**Figure 19:** LW Instruction Example

## 5.2.4 S-Type Store Instructions

Store instructions need to read two registers: *rs1* for base memory address and *rs2* for data to be stored, as well as an immediate offset. The effective byte address is obtained by adding register *rs1* to the sign-extended 12-bit offset. Note that stores don't write a value to the register file, as there is no *rd* register used by the instruction. In RISC-V, the lower 5 bits of immediate are moved to where the *rd* field was in other instructions, and the *rs1/rs2* fields are kept in same place. The registers are kept always in the same place because a critical path for all operations includes fetching values from the registers. By always placing the read sources in the same place, the register file can read the registers without hesitation. If the data ends up being unnecessary (e.g. I-Type), it can be ignored.

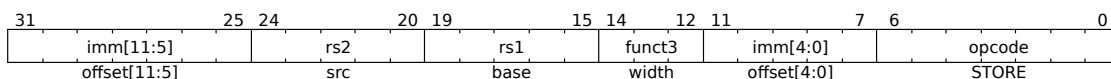

**Figure 20:** Store Instructions

imm			func3	imm	opcode	Instruction
imm[11:5]	rs2	rs1	000	imm[4:0]	01000011	SB
imm[11:5]	rs2	rs1	001	imm[4:0]	01000011	SH
imm[11:5]	rs2	rs1	010	imm[4:0]	01000011	SW

**Table 20:** S-Type Store Instructions

Instruction	Description
SB rs2, imm[11:0](rs1)	Store 8-bit value from the low bits of register rs2 to memory.
SH rs2, imm[11:0](rs1)	Store 16-bit value from the low bits of register rs2 to memory.
SW rs2, imm[11:0](rs1)	Store 32-bit value from the low bits of register rs2 to memory.

**Table 21:** S-Type Store Instruction Description

Below is an example SW instruction.

**sw x14, 8(x2)**

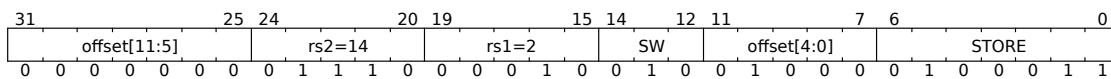

**Figure 21:** SW Instruction Example

### 5.2.5 Unconditional Jumps

The jump and link (JAL) instruction uses the J-type format, where the J-immediate encodes a signed offset in multiples of 2 bytes. The offset is sign-extended and added to the address of the jump instruction to form the jump target address. Jumps can therefore target a  $\pm 1$  MiB range. JAL stores the address of the instruction following the jump (pc+4) into register rd. The standard software calling convention uses x1 as the return address register and x5 as an alternate link register.

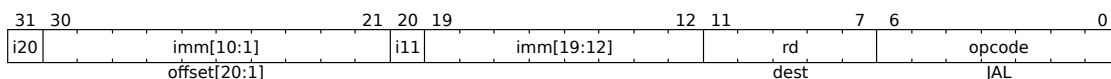

**Figure 22:** JAL Instruction

The indirect jump instruction JALR (jump and link register) uses the I-type encoding. The target address is obtained by adding the sign-extended 12-bit I-immediate to the register rs1, then setting the least-significant bit of the result to zero. The address of the instruction following the jump (pc+4) is written to register rd. Register x0 can be used as the destination if the result is not required.

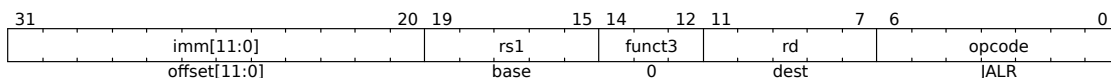

**Figure 23:** JALR Instruction

Both JAL and JALR instructions will generate an instruction-address-misaligned exception if the target address is not aligned to a four-byte boundary.

Instruction	Description
JAL rd, imm[20:1]	Jump and link
JALR rd, rs1, imm[11:0]	Jump and link register

**Table 22:** J-Type Instruction Description

### 5.2.6 Conditional Branches

All branch instructions use the B-Type instruction format. The 12-bit immediate represents values -4096 to +4094 in 2-byte increments. The offset is sign-extended and added to the address of the branch instruction to give the target address. The conditional branch range is  $\pm 4$  KiB.

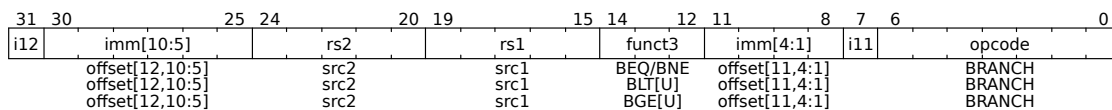

**Figure 24:** Branch Instructions

imm	rs2	rs1	func3	imm	opcode	Instruction
imm[12,10:5]	rs2	rs1	000	imm[4:1,11]	110011	BEQ
imm[12,10:5]	rs2	rs1	001	imm[4:1,11]	110011	BNE
imm[12,10:5]	rs2	rs1	100	imm[4:1,11]	110011	BLT
imm[12,10:5]	rs2	rs1	101	imm[4:1,11]	110011	BGE
imm[12,10:5]	rs2	rs1	110	imm[4:1,11]	110011	BLTU
imm[12,10:5]	rs2	rs1	111	imm[4:1,11]	110011	BGEU

**Table 23:** B-Type Instructions

Instruction	Description
BEQ rs1, rs2, imm[12:1]	Take the branch if registers rs1 and rs2 are equal.
BNE rs1, rs2, imm[12:1]	Take the branch if registers rs1 and rs2 are unequal.
BLT rs1, rs2, imm[12:1]	Take the branch if rs1 is less than rs2.
BGE rs1, rs2, imm[12:1]	Take the branch if rs1 is greater than or equal to rs2.
BLTU rs1, rs2, imm[12:1]	Take the branch if rs1 is less than rs2 (unsigned).
BGEU rs1, rs2, imm[12:1]	Take the branch if rs1 is greater than or equal to rs2 (unsigned).

**Table 24:** B-Type Instruction Description

ISA Base Instruction	Pseudoinstruction	Description
BEQ <i>rs, x0, offset</i>	BEQZ <i>rs, offset</i>	Take the branch if <i>rs</i> is equal to zero.

**Table 25:** RISC-V Base Instruction to Assembly Pseudoinstruction Example

**Note**

Software should be optimized such that the sequential code path is the most common path, with less-frequently taken code paths placed out of line. Software should also assume that backward branches will be predicted taken and forward branches as not taken, at least the first time they are encountered. Dynamic predictors should quickly learn any predictable branch behavior.

**5.2.7 Upper-Immediate Instructions**

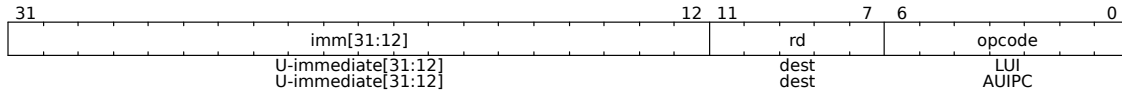

**Figure 25:** Upper-Immediate Instructions

LUI (load upper immediate) is used to build 32-bit constants and uses the U-type format. LUI places the U-immediate value in the top 20 bits of the destination register *rd*, filling in the lowest 12 bits with zeros. Together with an ADDI to set low 12 bits, can create any 32-bit value in a register using two instructions (LUI/ADDI).

For example:

**LUI x10, 0x87654 # x10 = 0x8765\_4000**

**ADDI x10, x10, 0x321 # x10 = 0x8765\_4321**

AUIPC (add upper immediate to pc) is used to build pc-relative addresses and uses the U-type format. AUIPC forms a 32-bit offset from the 20-bit U-immediate, filling in the lowest 12 bits with zeros, and adds this offset to the address of the AUIPC instruction, then places the result in register *rd*.

**5.2.8 Memory Ordering Operations**

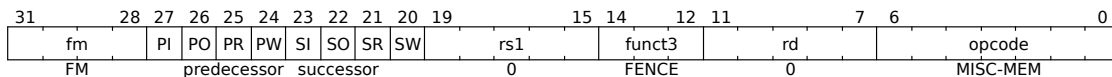

**Figure 26:** FENCE Instructions

The FENCE instruction is used to order device I/O and memory accesses as viewed by other RISC-V harts and external devices or coprocessors. Any combination of device input (I), device

output (O), memory reads (R), and memory writes (W) may be ordered with respect to any combination of the same. These operations are discussed further in Section 5.11.

### 5.2.9 Environment Call and Breakpoints

SYSTEM instructions are used to access system functionality that might require privileged access and are encoded using the I-type instruction format. These can be divided into two main classes: those that atomically read-modify-write control and status registers (CSRs), and all other potentially privileged instructions.

### 5.2.10 NOP Instruction

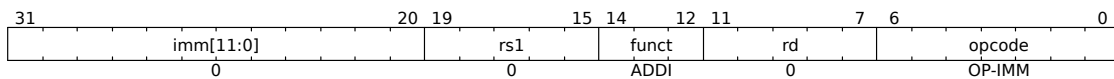

Figure 27: NOP Instructions

The NOP instruction does not change any architecturally visible state, except for advancing the pc and incrementing any applicable performance counters. NOP is encoded as **ADDI x0, x0, 0**.

## 5.3 M Extension: Multiplication Operations

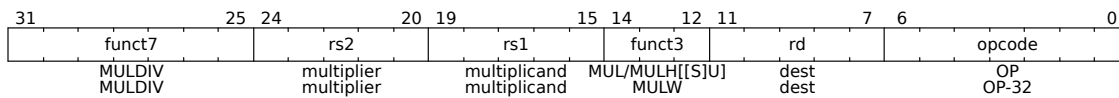

Figure 28: Multiplication Operations

Instruction	Description
MUL rd, rs1, rs2	Multiplication of rs1 by rs2 and places the lower 32-bits in the destination register.
MULH rd, rs1, rs2	Multiplication that return the upper 32-bits of the full 2×32-bit product.
MULHU rd, rs1, rs2	Unsigned multiplication that return the upper 32-bits of the full 2×32-bit product.
MULHSU rd, rs1, rs2	Signed rs1 multiple unsigned rs2 that return the upper 32-bits of the full 2×32-bit product.

Table 26: Multiplication Operation Description

Combining MUL and MULH together creates one multiplication operation.

### 5.3.1 Division Operations

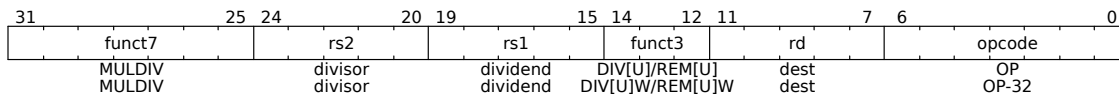

Figure 29: Division Operations

Instruction	Description
DIV rd, rs1, rs2	32-bits by 32-bits signed division of r1 by rs2 rounding towards zero.
DIVU rd, rs1, rs2	32-bits by 32-bits unsigned division of r1 by rs2 rounding towards zero.
REM rd, rs1, rs2	Remainder of the corresponding division.
REMU rd, rs1, rs2	Unsigned remainder of the corresponding division.
REMW rd, rs1, rs2	Singed remainder.
REMUW rd, rs1, rs2	Unsigned remainder sign-extend the 32-bit result to 64 bits, including on a divide by zero.
MULDIV rd, rs1, rs	Multiply Divide.

Table 27: Division Operation Description

Combining DIV and REM together creates one division operation.

## 5.4 A Extension: Atomic Operations

Atomic operations are defined as operations that automatically read-modify-write memory to support sychronization between multiple RISC-V harts running in the same memory space.

### 5.4.1 Atomic Memory Operations (AMOs)

The atomic memory operation (AMO) instructions perform read-modify-write operations for multiprocessor synchronization. These AMO instructions atomically load a data value from the address in rs1, place the value into register rd, apply a binary operator to the loaded value and the original value in rs2, then store the result back to the address in rs1.

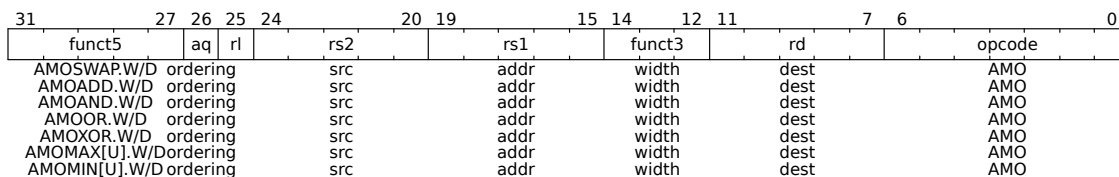

Figure 30: Atomic Memory Operations

Instruction	Description
AMOSWAP.W/D	Word / doubleword swap.
AMOADD.W/D	Word / doubleword add.
AMOAND.W/D	Word / doubleword and.
AMOOR.W/D	Word / doubleword or.
AMOXOR.W/D	Word / doubleword xor.
AMOMIN.W/D	Word / doubleword minimum.
AMOMINU.W/D	Unsigned word / doubleword minimum.
AMOMAX.W/D	Word / doubleword maximum.
AMOMAXU.W/D	Unsigned word / doubleword maximum.

**Table 28:** Atomic Memory Operation Description

## 5.5 F Extension: Single-Precision Floating-Point Instructions

The F Extension implements single-precision floating-point computational instructions compliant with the IEEE 754-2008 arithmetic standard. The F Extension adds 32 floating-point registers,  $f_0$ – $f_{31}$ , each 32 bits wide, and a floating-point control and status register  $fcsr$ . Floating-point load and store instructions transfer floating-point values between registers and memory, and instructions to transfer values to and from the integer register file are also provided.

### 5.5.1 Floating-Point Control and Status Registers

Floating-Point Control and Status Register,  $fcsr$ , is a RISC-V control and status register (CSR). The register selects the dynamic rounding mode for floating-point arithmetic operations and holds the accrued exception flags.

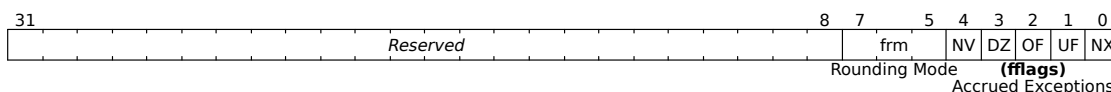

**Figure 31:** Floating-Point Control and Status Register

Flag Mnemonic	Flag Meaning
NV	Invalid Operation
DZ	Divide by Zero
OF	Overflow
UF	Underflow
NX	Inexact

**Table 29:** Accrued Exception Flags

The  $fcsr$  register can be read and written with the FRCSR and FSCSR instructions. The FRRM instruction reads the Rounding Mode field  $frm$ . FSRM swaps the value in  $frm$  with an integer register. FRFLAGS and FSFLAGS are defined analogously for the Accrued Exception Flags field  $fflags$ .



### 5.5.2 Rounding Modes

Floating-point operations use either a static rounding mode encoded in the instruction, or a dynamic rounding mode held in *frm*. A value of 111 in the instruction's *rm* field selects the dynamic rounding mode held in *frm*. If *frm* is set to an invalid value (101–111), any subsequent attempt to execute a floating-point operation with a dynamic rounding mode will raise an illegal instruction exception. Some instructions, including widening conversions, have the *rm* field, but are nevertheless unaffected by the rounding mode. Software should set their *rm* field to RNE (000).

Mode	Mnemonic	Meaning
000	RNE	Round to Nearest, ties to Even.
001	RTZ	Round towards Zero.
010	RDN	Round Down (towards $-\infty$ ).
011	RUP	Round Up (towards $+\infty$ ).
100	RMM	Round to Nearest, ties to Max Magnitude.
101		<i>Invalid. Reserved for future use.</i>
110		<i>Invalid. Reserved for future use.</i>
111	DYN	In instruction's <i>rm</i> field, selects dynamic rounding mode; In Rounding Mode register, <i>Invalid</i> .

**Table 30:** Floating-Point Rounding Modes

### 5.5.3 Single-Precision Floating-Point Load and Store Instructions

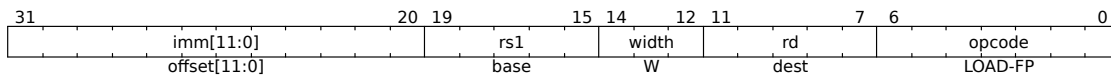

**Figure 32:** Single-Precision FP Load Instruction

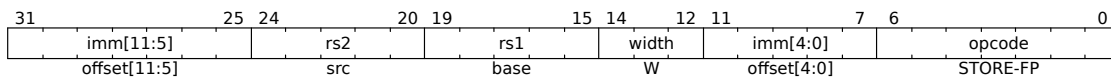
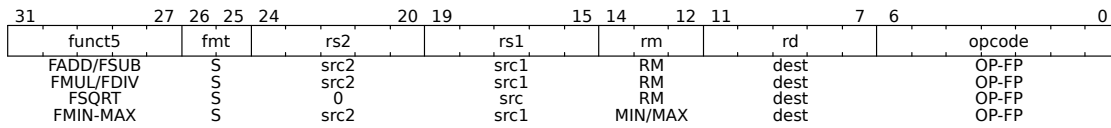

**Figure 33:** Single-Precision FP Store Instruction

Instruction	Operation	Description
FLW <i>rd, rs1, imm</i>	$f[rd] = M[x[rs1] + sext(offset)][31:0]$	Loads a single-precision floating-point value from memory into floating-point register <i>rd</i> .
FSW <i>imm, rs1, rs2</i>	$M[x[rs1] + sext(offset)] = f[rs2][31:0]$	Stores a single-precision value from floating-point register <i>rs2</i> to memory.

**Table 31:** Single-Precision FP Load and Store Instructions Description

### 5.5.4 Single-Precision Floating-Point Computational Instructions



**Figure 34:** Single-Precision FP Computational Instructions

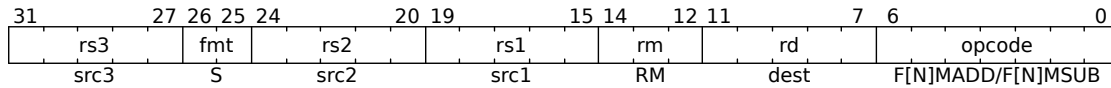

**Figure 35:** Single-Precision FP Fused Computational Instructions

Instruction	Operation	Description
FADD.S rd,rs1,rs2	$f[rd] = f[rs1] + f[rs2]$	Single-precision floating-point addition.
FSUB.S rd,rs1,rs2	$f[rd] = f[rs1] - f[rs2]$	Single-precision floating-point subtraction.
FMUL.S rd,rs1,rs2	$f[rd] = f[rs1] \times f[rs2]$	Single-precision floating-point multiplication.
FDIV.S rd,rs1,rs2	$f[rd] = f[rs1] \div f[rs2]$	Single-precision floating-point division.
FSQRT.S rd,rs1	$f[rd] = \sqrt{f[rs1]}$	Single-precision floating-point square root.
FMIN.S rd,rs1,rs2	$f[rd] = \min(f[rs1], f[rs2])$	Single-precision floating-point minimum-number.
FMAX.S rd,rs1,rs2	$f[rd] = \max(f[rs1], f[rs2])$	Single-precision floating-point maximum-number.
FMADD.S rd,rs1,rs2,rs3	$f[rd] = (f[rs1] \times f[rs2]) + f[rs3]$	Single-precision floating-point multiply and add.
FMSUB.S rd,rs1,rs2,rs3	$f[rd] = (f[rs1] \times f[rs2]) - f[rs3]$	Single-precision floating-point multiply and subtract.
FNMADD.S rd,rs1,rs2,rs3	$f[rd] = -(f[rs1] \times f[rs2]) + f[rs3]$	Single-precision floating-point multiply, negate, and add.
FNMSUB.S rd,rs1,rs2,rs3	$f[rd] = -(f[rs1] \times f[rs2]) - f[rs3]$	Single-precision floating-point multiply, negate, and subtract.

**Table 32:** Single-Precision FP Computational Instructions Description

### 5.5.5 Single-Precision Floating-Point Conversion and Move Instructions

#### Single-Precision Floating-Point Conversion Instructions

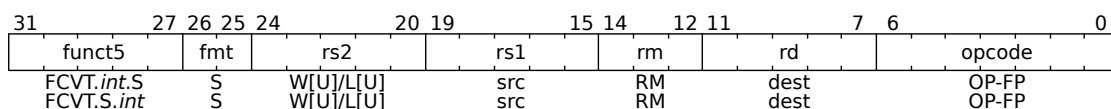

**Figure 36:** Single-Precision FP to Integer and Integer to FP Conversion Instructions

Instruction	Operation	Description
FCVT.W.S rd, rs1	$x[rd] = \text{sext}(s32_{f32}(f[rs1]))$	Converts a single-precision floating-point number to a signed 32-bit integer.
FCVT.S.W rd, rs1	$f[rd] = f32_{s32}(x[rs1])$	Converts a signed 32-bit integer to a single-precision floating-point number.
FCVT.WU.S rd, rs1	$x[rd] = \text{sext}(u32_{f32}(f[rs1]))$	Converts a single-precision floating-point number to an unsigned 32-bit integer.
FCVT.S.WU rd, rs1	$f[rd] = f32_{u32}(x[rs1])$	Converts an unsigned 32-bit integer to a single-precision floating-point number.

**Table 33:** Single-Precision FP Conversion Instructions Description

If the rounded result is not representable in the destination format, it is clipped to the nearest value and the invalid flag is set.

### Single-Precision Floating-Point to Floating-Point Sign-Injection Instructions

The floating-point to floating-point sign-injection instructions produce a result that takes all bits except the sign bit from rs1. The sign-injection instructions provide floating-point MV, ABS and NEG.

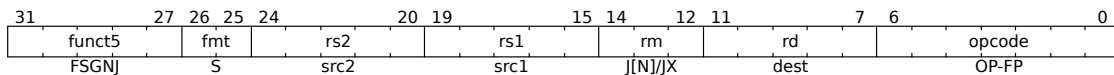

**Figure 37:** Single-Precision FP to FP Sign-Injection Instructions

Instruction	Operation	Description
FSGNJ.S rd, rs1, rs2	$f[rd] = \{f[rs2][31], f[rs1][30:0]\}$	Produces a result that takes all bits except the sign bit from rs1. The result's sign bit is rs2's sign bit.
FSGNJN.S rd, rs1, rs2	$f[rd] = \{-f[rs2][31], f[rs1][30:0]\}$	Produces a result that takes all bits except the sign bit from rs1. The result's sign bit is the opposite of rs2's sign bit.
FSGNJX.S rd, rs1, rs2	$f[rd] = \{f[rs1][31] \wedge f[rs2][31], f[rs1][30:0]\}$	Produces a result that takes all bits except the sign bit from rs1. The sign bit is the XOR of the sign bits of rs1 and rs2.

**Table 34:** Single-Precision FP to FP Sign-Injection Instructions Description

ISA Base Instruction	Pseudoinstruction	Description
FSGNJ.S <i>rx, ry, ry</i>	FMV.S <i>rx, ry</i>	Moves <i>ry</i> to <i>rx</i> .
FSGNJN.S <i>rx, ry, ry</i>	FNEG.S <i>rx, ry</i>	Moves the negation of <i>ry</i> to <i>rx</i> .
FSGNJX.S <i>rx, ry, ry</i>	FABS.S <i>rx, ry</i>	Moves the absolute value of <i>ry</i> to <i>rx</i> .

**Table 35:** RISC-V Base Instruction to Assembly Pseudoinstruction Example

### Single-Precision Floating-Point Move Instructions

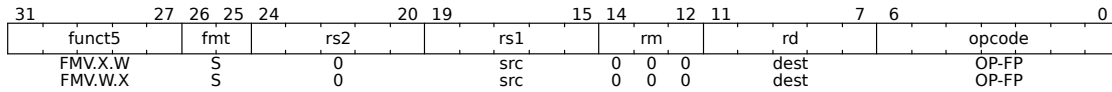
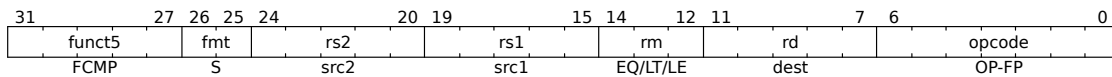

**Figure 38:** Single-Precision FP Move Instructions

Instruction	Operation	Description
FMV.X.W <i>rd, rs1</i>	$x[rd] = \text{sext}(f[rs1][31:0])$	Moves the single-precision value in floating-point register <i>rs1</i> represented in IEEE 754-2008 encoding to the lower 32 bits of integer register <i>rd</i> .
FMV.W.X <i>rd, rs1</i>	$f[rd] = x[rs1][31:0]$	Moves the single-precision value encoded in IEEE 754-2008 standard encoding from the lower 32 bits of integer register <i>rs1</i> to the floating-point register <i>rd</i> .

**Table 36:** Single-Precision FP Move Instructions Description

### 5.5.6 Single-Precision Floating-Point Compare Instructions

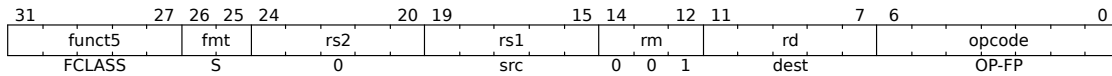

**Figure 39:** Single-Precision FP Compare Instructions

Instruction	Operation	Description
FEQ.S rd, rs1, rs2	$x[rd] = f[rs1] == f[rs2]$	Writes 1 to the integer register rd if rs1 is equal to rs2, 0 otherwise. Performs a quiet comparison; only sets the invalid operation exception flag if either input is a signaling NaN.
FLT.S rd, rs1, rs2	$x[rd] = f[rs1] < f[rs2]$	Writes 1 to the integer register rd if rs1 less than rs2, 0 otherwise. Performs signaling comparisons; sets the invalid operation exception flag if either input is NaN.
FLE.S rd, rs1, rs2	$x[rd] = f[rs1] \leq f[rs2]$	Writes 1 to the integer register rd if rs1 less than or equal to rs2, 0 otherwise. Performs signaling comparisons; sets the invalid operation exception flag if either input is NaN.

**Table 37:** Single-Precision FP Compare Instructions Description

**Single-Precision Floating-Point Classify Instruction**



**Figure 40:** Single-Precision FP Classify Instruction

Instruction	Operation	Description
FCLASS.S rd, rs1	$x[rd] = \text{classify}_s(f[rs1])$	Examines the value in floating-point register rs1 and writes to integer register rd a 10-bit mask that indicates the class of the floating-point number.

**Table 38:** Single-Precision FP Classify Instruction Description

rd bit	Meaning
0	rs1 is $-\infty$
1	rs1 is negative normal number
2	rs1 is a negative subnormal number
3	rs1 is -0
4	rs1 is +0
5	rs1 is a positive subnormal number
6	rs1 is a positive normal number
7	rs1 is $+\infty$
8	rs1 is a signaling NaN
9	rs1 is a quiet NaN

**Table 39:** Floating-Point Number Classes

## 5.6 C Extension: Compressed Instructions

The C Extension reduces static and dynamic code size by adding short 16-bit instruction encodings for common operations. The C extension can be added to any of the base ISAs (RV32, RV64, RV128), and we use the generic term "RVC" to cover any of these. Typically, 50%–60% of the RISC-V instructions in a program can be replaced with RVC instructions, resulting in a 25%–30% code-size reduction. The C extension is compatible with all other standard instruction extensions. The C extension allows 16-bit instructions to be freely intermixed with 32-bit instructions, with the latter now able to start on any 16-bit boundary, i.e., IALIGN=16. With the addition of the C extension, no instructions can raise instruction-address-misaligned exceptions. It is important to note that the C extension is not designed to be a stand-alone ISA, and is meant to be used alongside a base ISA. The compressed 16-bit instruction format is designed around the assumption that x1 is the return address register and x2 is the stack pointer.

### 5.6.1 Compressed 16-bit Instruction Formats

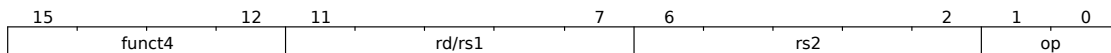

**Figure 41:** CR Format - Register

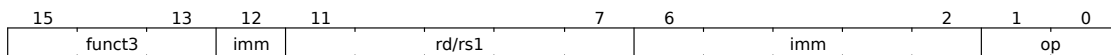

**Figure 42:** CI Format - Immediate

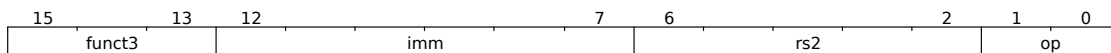

**Figure 43:** CSS Format - Stack-relative Store

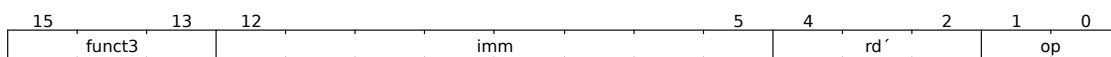

**Figure 44:** CIW Format - Wide Immediate

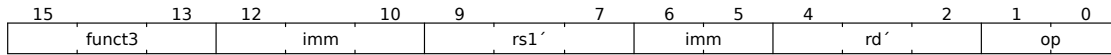

Figure 45: CL Format - Load

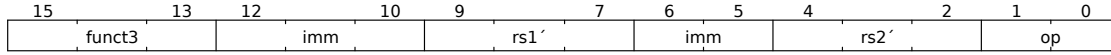

Figure 46: CS Format - Store

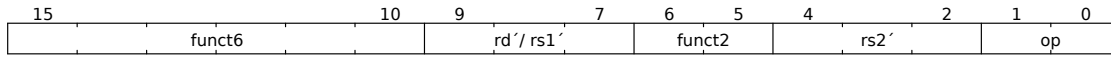

Figure 47: CA Format - Arithmetic

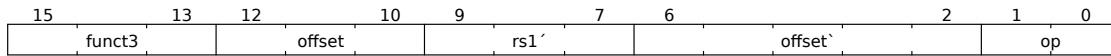

Figure 48: CJ Format - Jump

### 5.6.2 Stack-Pointed-Based Loads and Stores

The compressed load instructions are expressed in CI format.

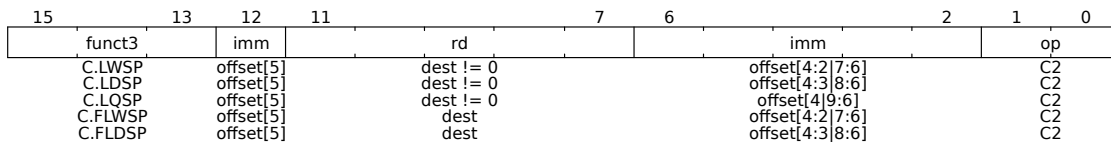

Figure 49: Stack-Pointed-Based Loads

Instruction	Description
C.LWSP	Loads a 32-bit value from memory into register rd.
C.LDSP	RV64C Instruction which loads a 64-bit value from memory into register rd.
C.LQSP	RV128C loads a 128-bit value from memory into register rd.
C.FLWSP	RV32FC Instruction that loads a single-precision floating-point value from memory into floating-point register rd.
C.FLDSP	RV32DC/RV64DC Instruction that loads a double-precision floating-point value from memory into floating-point register rd.

Table 40: Stack-Pointed-Based Load Instruction Description

The compressed store instructions are expressed in CSS format.

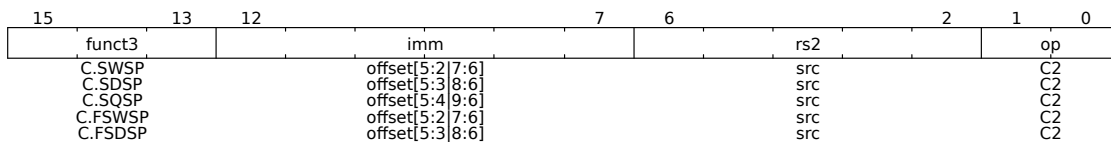

Figure 50: Stack-Pointed-Based Stores

Instruction	Description
C.LWSP	Loads a 32-bit value from memory into register rd.
C.SWSP	Stores a 32-bit value in register rs2 to memory.
C.SDSP	RV64C/RV128C instruction that stores a 64-bit value in register rs2 to memory.
C.SQSP	RV128C instruction that stores a 128-bit value in register rs2 to memory.
C.FSWSP	RV32FC instruction that stores a single-precision floating-point value in floating-point register rs2 to memory.
C.FSDSP	RV32DC/RV64DC instruction that stores a double-precision floating-point value in floating-point register rs2 to memory.

**Table 41:** Stack-Pointed-Based Store Instruction Description

### 5.6.3 Register-Based Loads and Stores

The compressed register-based load instructions are expressed in CL format.

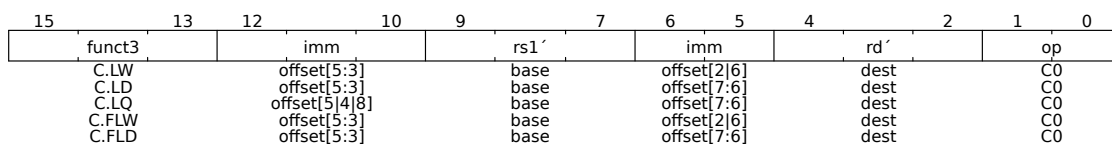
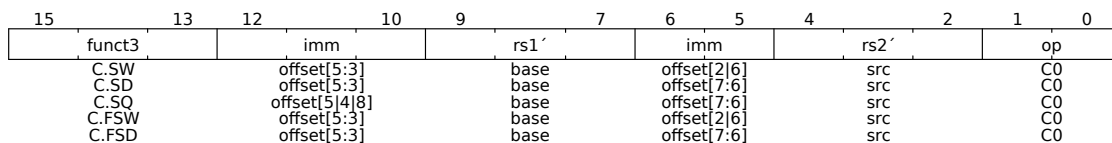

**Figure 51:** Register-Based Loads

Instruction	Description
C.LW	Loads a 32-bit value from memory into register rd.
C.LD	RV64C/RV128C-only instruction that loads a 64-bit value from memory into register rd.
C.LQ	RV128C-only instruction that loads a 128-bit value from memory into register rd.
C.FLW	RV32FC-only instruction that loads a single-precision floating-point value from memory into floating-point register rd.
C.FLD	RV32DC/RV64DC-only instruction that loads a double-precision floating-point value from memory into floating-point register rd.

**Table 42:** Register-Based Load Instruction Description

The compressed register-based store instructions are expressed in CS format.



**Figure 52:** Register-Based Stores



Instruction	Description
C.SW	Stores a 32-bit value in register rs2 to memory.
C.SD	RV64C/RV128C instruction that stores a 64-bit value in register rs2 to memory.
C.SQ	RV128C instruction that stores a 128-bit value in register rs2 to memory.
C.FSW	RV32FC instruction that stores a single-precision floating-point value in floating point register rs2 to memory.
C.FSD	RV32DC/RV64DC instruction that stores a double-precision floating-point value in floating-point register rs2 to memory.

**Table 43:** Register-Based Store Instruction Description

### 5.6.4 Control Transfer Instructions

RVC provides unconditional jump instructions and conditional branch instructions.

The unconditional jump instructions are expressed in CJ format.

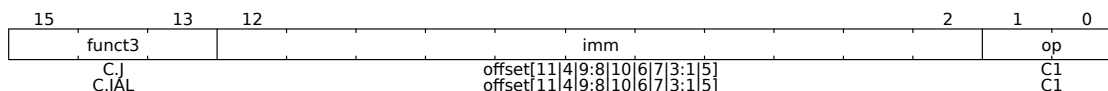

**Figure 53:** Unconditional Jump Instructions

Instruction	Description
C.J	Unconditional control transfer.
C.JAL	RV32C instruction that performs the same operation as C.J, but additionally writes the address of the instruction following the jump (pc+2) to the link register, x1.

**Table 44:** Unconditional Jump Instruction Description

The unconditional control transfer instructions are expressed in CR format.

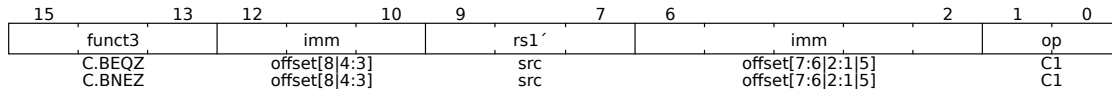

**Figure 54:** Unconditional Control Transfer Instructions

Instruction	Description
C.JR	Performs an unconditional control transfer to the address in register rs1.
C.JALR	Performs the same operation as C.JR, but additionally writes the address of the instruction following the jump (pc+2) to the link register, x1.

**Table 45:** Unconditional Control Transfer Instruction Description

The conditional control transfer instructions are expressed in CB format.



**Figure 55:** Conditional Control Transfer Instructions

Instruction	Description
C.BEQZ	Conditional control transfers. Takes the branch if the value in register <i>rs1'</i> is zero.
C.BNEZ	Conditional control transfers. Takes the branch if <i>rs1'</i> contains a nonzero value.

**Table 46:** Conditional Control Transfer Instruction Description

### 5.6.5 Integer Computational Instructions

#### Integer Constant-Generation Instructions

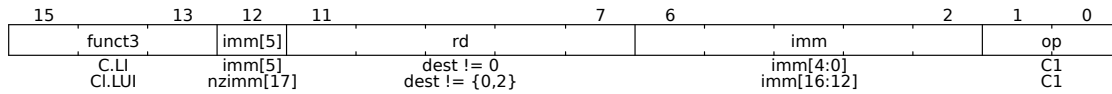
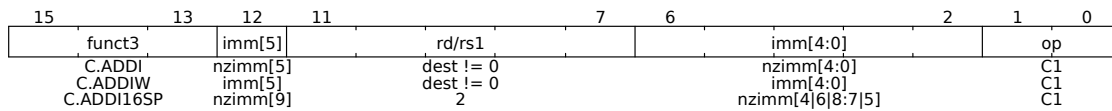

**Figure 56:** Integer Constant-Generation Instructions

Instruction	Description
C.LI	Loads the sign-extended 6-bit immediate, <i>imm</i> , into register <i>rd</i> .
C.LUI	Loads the non-zero 6-bit immediate field into bits 17–12 of the destination register, clears the bottom 12 bits, and sign-extends bit 17 into all higher bits of the destination

**Table 47:** Integer Constant-Generation Instruction Description

#### Integer Register-Immediate Operations



**Figure 57:** Integer Register-Immediate Operations

Instruction	Description
C.ADDI	Adds the non-zero sign-extended 6-bit immediate to the value in register <i>rd</i> then writes the result to <i>rd</i> .
C.ADDIW	RV64C/RV128C instruction that performs the same computation but produces a 32-bit result, then sign-extends result to 64 bits.
C.ADDI16SP	Adds the non-zero sign-extended 6-bit immediate to the value in the stack pointer ( <i>sp=x2</i> ), where the immediate is scaled to represent multiples of 16 in the range (-512,496). C.ADDI16SP is used to adjust the stack pointer in procedure prologues and epilogues.

**Table 48:** Integer Register-Immediate Operation Description

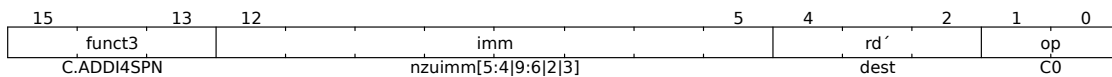

**Figure 58:** Integer Register-Immediate Operations (con't)

Instruction	Description
C.ADDI4SPN	Adds a zero-extended non-zero immediate, scaled by 4, to the stack pointer, <i>x2</i> , and writes the result to <i>rd'</i> .

**Table 49:** Integer Register-Immediate Operation Description (con't)

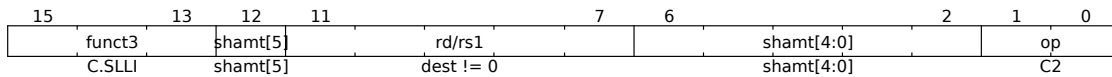

**Figure 59:** Integer Register-Immediate Operations (con't)

Instruction	Description
C.SLLI	Performs a logical left shift of the value in register <i>rd</i> then writes the result to <i>rd</i> . The shift amount is encoded in the <i>shamt</i> field.

**Table 50:** Integer Register-Immediate Operation Description (con't)

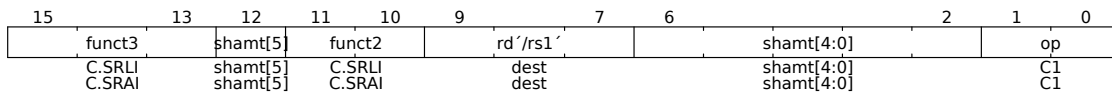

**Figure 60:** Integer Register-Immediate Operations (con't)

Instruction	Description
C.SRLI	Logical right shift of the value in register <i>rd'</i> then writes the result to <i>rd'</i> . The shift amount is encoded in the <i>shamt</i> field.
C.SRAI	Arithmetic right shift of the value in register <i>rd'</i> then writes the result to <i>rd'</i> . The shift amount is encoded in the <i>shamt</i> field.

**Table 51:** Integer Register-Immediate Operation Description (con't)

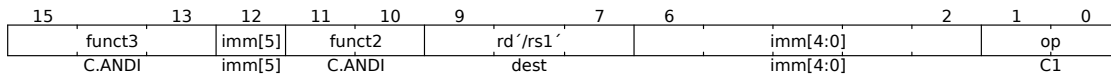
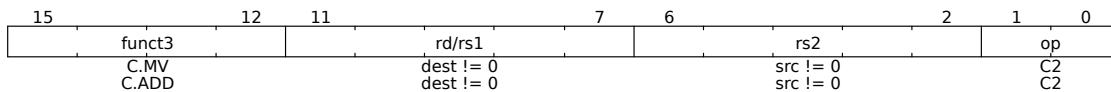

**Figure 61:** Integer Register-Immediate Operations (con't)

Instruction	Description
C.ANDI	Computes the bitwise AND of the value in register rd' and the sign-extended 6-bit immediate, then writes the result to rd'.

**Table 52:** Integer Register-Immediate Operation Description (con't)

**Integer Register-Register Operations**



**Figure 62:** Integer Register-Register Operations

Instruction	Description
C.MV	Copies the value in register rs2 into register rd.
C.ADD	Adds the values in registers rd and rs2 and writes the result to register rd.

**Table 53:** Integer Register-Register Operation Description

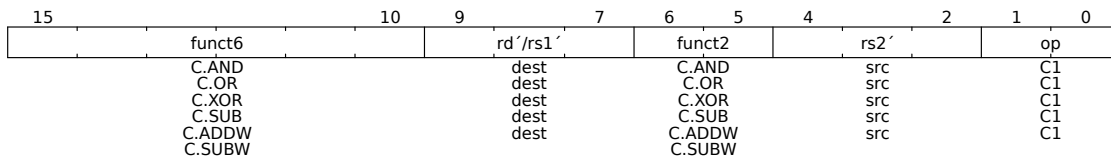

**Figure 63:** Integer Register-Register Operations (con't)

Instruction	Description
C.AND	Computes the bitwise AND of the values in registers rd' and rs2'.
C.OR	Computes the bitwise OR of the values in registers rd' and rs2'.
C.XOR	Computes the bitwise XOR of the values in registers rd' and rs2'.
C.SUB	Subtracts the value in register rs2' from the value in register rd'.
C.ADDW	RV64C/RV128C-only instruction that adds the values in registers rd' and rs2', then sign-extends the lower 32 bits of the sum before writing the result to register rd.
C.SUBW	RV64C/RV128C-only instruction that subtracts the value in register rs2' from the value in register rd', then sign-extends the lower 32 bits of the difference before writing the result to register rd.

**Table 54:** Integer Register-Register Operation Description (con't)

### Defined Illegal Instruction

A 16-bit instruction with all bits zero is permanently reserved as an illegal instruction.

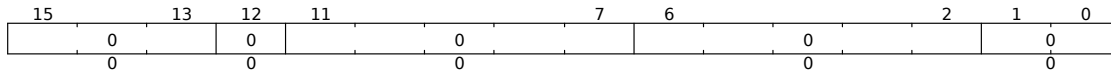

**Figure 64:** Defined Illegal Instruction

## 5.7 Zicsr Extension: Control and Status Register Instructions

RISC-V defines a separate address space of 4096 Control and Status registers associated with each hart. The defined instructions access counter, timers and floating point status registers.

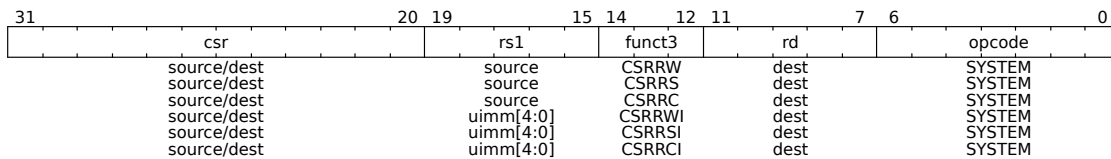

**Figure 65:** Zicsr Instructions

Instruction	Description
CSRRW rd, rs1 csr	Instruction atomically swaps values in the CSRs and integer registers.
CSRRS rd, rs1 csr	Instruction reads the value of the CSR, zeroextends the value to 32-bits, and writes it to integer register rd. The initial value in integer register rs1 is treated as a bit mask that specifies bit positions to be set in the CSR.
CSRRC rd, rs1 csr	Instruction reads the value of the CSR, zeroextends the value to 32-bits, and writes it to integer register rd. The initial value in integer register rs1 is treated as a bit mask that specifies bit positions to be cleared in the CSR.
CSRRWI rd, rs1 csr	Update the CSR using an 32-bit value obtained by zero-extending a 5-bit unsigned immediate (uimm[4:0]) field encoded in the rs1 field instead of a value from an integer register.
CSRRSI rd, rs1 csr	Update the CSR using an 32-bit value obtained by zero-extending a 5-bit unsigned immediate (uimm[4:0]) field encoded in the rs1 field instead of a value from an integer register.
CSRRCI rd, rs1 csr	If the uimm[4:0] field is zero, then these instructions will not write to the CSR.

**Table 55:** Control and Status Register Instruction Description

The CSRRWI, CSRRSI, and CSRRCI instructions are similar in kind to CSRRW, CSRRS, and CSRRC respectively, except in that they update the CSR using an 32-bit value obtained by zero-extending a 5-bit unsigned immediate (uimm[4:0]) field encoded in the rs1 field instead of a value from an integer register. For CSRRSI and CSRRCI, these instructions will not write to the

CSR if the `uimm[4:0]` field is zero, and they shall not cause any of the size effects that might otherwise occur on a CSR write. For CSRRWI, if `rd = x0`, then the instruction shall not read the CSR and shall not cause any of the side effects that might occur on a CSR read. Both CSRRSI and CSRRCI will always read the CSR and cause any read side effects regardless of the `rd` and `rs1` fields.

Table 56 shows if a CSR reads or writes given a particular CSR.

Register Operand				
Instruction	rd	rs1	read CSR?	write CSR?
CSRRW	<code>x0</code>	-	no	yes
CSRRW	<code>!x0</code>	-	yes	yes
CSRRS/C	-	<code>x0</code>	yes	no
CSRRS/C	-	<code>!x0</code>	yes	yes
Immediate Operand				
Instruction	rd	uimm	read CSR?	write CSR?
CSRRWI	<code>x0</code>	-	no	yes
CSRRWI	<code>!x0</code>	-	yes	yes
CSRRS/CI	-	0	yes	no
CSRRS/CI	-	<code>!0</code>	yes	yes

**Table 56:** CSR Reads and Writes

### 5.7.1 Control and Status Registers

The control and status registers (CSRs) are only accessible using variations of the CSRR (Read) and CSRRW (Write) instructions. Only the CPU executing the `csr` instruction can read or write these registers, and they are not visible by software outside of the core they reside on. The standard RISC-V ISA sets aside a 12-bit encoding space (`csr[11:0]`) for up to 4,096 CSRs. Attempts to access a non-existent CSR raise an illegal instruction exception. Attempts to access a CSR without appropriate privilege level or to write a read-only register also raise illegal instruction. A read/write register might also contain some bits that are read-only, in which case, writes to the read-only bits are ignored. Each core functionality has its own control and status registers which are described in the corresponding section.

### 5.7.2 Defined CSRs

The following tables describe the currently defined CSRs, categorized by privilege level. The usage of the CSRs below is implementation specific. CSRs are only accessible when operating within a specific access mode (user mode, debug mode, supervisor mode, or machine mode). Therefore, attempts to access a non-existent CSR raise an illegal instruction exception, and attempts to access a CSR without appropriate privilege level or to write a read-only register also raise illegal instruction exceptions.

Number	Privilege	Name	Description
<b>User Trap Setup</b>			
0x000	RW	ustatus	User status register.
0x004	RW	uie	User interrupt-enable register.
0x005	RW	utvec	User trap handler base address.
<b>User Trap Handling</b>			
0x040	RW	uscratch	Scratch register for use trap handlers.
0x041	RW	uepc	User exception program counter.
0x042	RW	ucause	User trap cause.
0x043	RW	ubadaddr	User bad address.
0x044	RW	uip	User interrupt pending.
<b>User Floating-Point CSRs</b>			
0x001	RW	fflags	Floating-Point Accrued Exceptions.
0x002	RW	frm	Floating-Point Dynamic Rounding Mode.
0x003	RW	fcsr	Floating-Point Control and Status Register (frm + fflags).
<b>User Counter/Timers</b>			
0xC00	RO	cycle	Cycle counter for RDCYCLE instruction.
0xC01	RO	time	Timer for RDTIME instruction.
0xC02	RO	instret	Instructions-retired counter for RDINSTRET instruction.
0xC03	RO	hpmcounter3	Performance-monitoring counter.
0xC04	RO	hpmcounter4	Performance-monitoring counter.
		...	
0xC1F	RO	hpmcounter31	Performance-monitoring counter.
0xC80	RO	cycleh	Upper 32 bits of cycle, RV32I only.
0xC81	RO	timeh	Upper 32 bits of time, RV32I only.
0xC82	RO	instreth	Upper 32 bits of instret, RV32I only.
0xC83	RO	hpmcounter3h	Upper 32bits of hpmcounter3, RV32I only.
0xC84	RO	hpmcounter4h	Upper 32bits of hpmcounter4, RV32I only.
		...	
0xC9F	RO	hpmcounter31h	Upper 32bits of hpmcounter31, RV32I only.

**Table 57:** User Mode CSRs

Number	Privilege	Name	Description
<b>Machine Information Registers</b>			
0xF11	RO	mvendorid	Vendor ID.
0xF12	RO	marchid	Architecture ID.
0xF13	RO	mimpid	Implementation ID.
0xF14	RO	mhartid	Hardware thread ID.
<b>Machine Trap Setup</b>			
0x300	RW	mstatus	Machine status register.
0x301	RW	misa	ISA and extensions.
0x302	RW	medeleg	Machine exception delegation register.
0x303	RW	mideleg	Machine interrupt delegation register.
0x304	RW	mie	Machine interrupt-enable register.
0x305	RW	mtvec	Machine trap-handler base address.
0x306	RW	mcounteren	Machine counter enable.
<b>Machine Trap Handling</b>			
0x340	RW	mscratch	Scratch register for machine trap handlers.
0x341	RW	mepc	Machine exception program counter.
0x342	RW	mcause	Machine trap cause.
0x343	RW	mtval	Machine bad address or instruction.
0x344	RW	mip	Machine interrupt pending.
<b>Machine Memory Protection</b>			
0x3A0	RW	pmpcfg0	Physical memory protection configuration.
0x3A1	RW	pmpcfg1	Physical memory protection configuration, RV32 only.
0x3A2	RW	pmpcfg2	Physical memory protection configuration.
0x3A3	RW	pmpcfg3	Physical memory protection configuration, RV32 only.
0x3B0	RW	pmpaddr0	Physical memory protection address register.
0x3B1	RW	pmpaddr1	Physical memory protection address register.
		...	
0x3BF	RW	pmpaddr15	Physical memory protection address register.
<b>Machine Counter/Timers</b>			
0xB00	RW	mcycle	Machine cycle counter.
0xB02	RW	minstret	Machine instruction-retired counter.
0xB80	RW	mcycleh	Upper 32 bits of <code>mcycle</code> , RV32I only.
0xB82	RW	minstreth	Upper 32 bits of <code>minstret</code> , RV32I only.
0xB83	RW	mhpmcounter3h	Upper 32 bits of <code>mhpmcounter3</code> , RV32I only.
0xB84	RW	mhpmcounter4h	Upper 32 bits of <code>mhpmcounter4</code> , RV32I only.
		...	
0xB9F	RW	mhpmcounter31h	Upper 32 bits of <code>mhpmcounter31</code> , RV32I only.
<b>Machine Counter Setup</b>			
0x320	RW	mcountinhibit	Machine counter-inhibit register.

**Table 58:** Machine Mode CSRs



Number	Privilege	Name	Description
0x323	RW	mhpmevent3	Machine performance-monitoring event selector.
0x324	RW	mhpmevent4	Machine performance-monitoring event selector.
		...	
0x33F	RW	mhpmevent31	Machine performance-monitoring event selector.
Debug/Trace Register (shared with Debug Mode)			
0x7A0	RW	tselect	Debug/Trace trigger register select.
0x7A1	RW	tdata1	First Debug/Trace trigger data register.
0x7A2	RW	tdata2	Second Debug/Trace trigger data register.
0x7A3	RW	tdata3	Third Debug/Trace trigger data register.

**Table 58:** Machine Mode CSRs

Number	Privilege	Name	Description
0x7B0	RW	dcsr	Debug control and status register.
0x7B1	RW	dpc	Debug PC.
0x7B2	RW	dscratch	Debug scratch register.

**Table 59:** Debug Mode Registers

### 5.7.3 CSR Access Ordering

On a given hart, explicit and implicit CSR access are performed in program order with respect to those instructions whose execution behavior is affected by the state of the accessed CSR. In particular, a CSR access is performed after the execution of any prior instructions in program order whose behavior modifies or is modified by the CSR state and before the execution of any subsequent instructions in program order whose behavior modifies or is modified by the CSR state.

Furthermore, a CSR read access instruction returns the accessed CSR state before the execution of the instruction, while a CSR write access instruction updates the accessed CSR state after the execution of the instruction. Where the above program order does not hold, CSR accesses are weakly ordered, and the local hart or other harts may observe the CSR accesses in an order different from program order. In addition, CSR accesses are not ordered with respect to explicit memory accesses, unless a CSR access modifies the execution behavior of the instruction that performs the explicit memory access or unless a CSR access and an explicit memory access are ordered by either the syntactic dependencies defined by the memory model or the ordering requirements defined by the Memory-Ordering PMAs. To enforce ordering in all other cases, software should execute a FENCE instruction between the relevant accesses. For the purposes of the FENCE instruction, CSR read accesses are classified as device input (I), and CSR write accesses are classified as device output (O). For more about the FENCE instructions, see Section 5.11. For CSR accesses that cause side effects, the above ordering constraints apply to the order of the initiation of those side effects but does not necessarily apply to the order of the completion of those side effects.

## 5.7.4 SiFive RISC-V Implementation Version Registers

### `mvendorid`

The value in `mvendorid` is 0x489, corresponding to SiFive's JEDEC number.

### `marchid`

The value in `marchid` indicates the overall microarchitecture of the core and at SiFive we use this to distinguish between core generators. The RISC-V standard convention separates `marchid` into open-source and proprietary namespaces using the most-significant bit (MSB) of the `marchid` register; where if the MSB is clear, the `marchid` is for an open-source core, and if the MSB is set, then `marchid` is a proprietary microarchitecture. The open-source namespace is managed by the RISC-V Foundation and the proprietary namespace is managed by SiFive.

SiFive's E3 and S5 cores are based on the open-source 3/5-Series microarchitecture, which has a Foundation-allocated `marchid` of 1. Our other generators are numbered according to the core series.

Value	Core Generator
0x1	3/5-Series Processor (E3, S5, U5 series)

**Table 60:** Core Generator Encoding of `marchid`

### `mimpid`

The value in `mimpid` holds an encoded value that uniquely identifies the version of the generator used to build this implementation. If your release version is not included in Table 61, contact your SiFive account manager for more information.

Value	Generator Release Version
0x0000_0000	Pre-19.02
0x2019_0228	19.02
0x2019_0531	19.05
0x2019_0919	19.08p0p0 / 19.08.00
0x2019_1105	19.08p1p0 / 19.08.01.00
0x2019_1204	19.08p2p0 / 19.08.02.00
0x2020_0423	19.08p3p0 / 19.08.03.00
0x0120_0626	19.08p4p0 / 19.08.04.00
0x0220_0515	koala.00.00-preview and koala.01.00-preview
0x0220_0603	koala.02.00-preview
0x0220_0630	20G1.03.00 / koala.03.00-general
0x0220_0710	20G1.04.00 / koala.04.00-general
0x0220_0826	20G1.05.00 / koala.05.00-general
0x0320_0908	kiwi.00.00-preview
0x0220_1013	20G1.06.00 / koala.06.00-general
0x0220_1120	20G1.07.00 / koala.07.00-general
0x0421_0205	llama.00.00-preview
0x0421_0324	21G1.01.00 / llama.01.00-general

**Table 61:** Generator Release Encoding of mimpid

### Reading Implementation Version Registers

To read the `mvendorid`, `marchid`, and `mimpid` registers, simply replace `mimpid` with `mvendorid` or `marchid` as needed.

#### In C:

```
uintptr_t mimpid;
__asm__ volatile("csrr %0, mimpid" : "=r"(mimpid));
```

#### In Assembly:

```
csrr a5, mimpid
```

## 5.7.5 Custom CSRs

SiFive implements some custom CSRs that are specific to the implementation. For these CSRs, including the Feature Disable CSR, consider Chapter 6.

## 5.8 Base Counters and Timers

RISC-V ISAs provide a set of up to 32×64-bit performance counters and timers that are accessible via unprivileged 32-bit read-only CSR registers 0xc00–0xc1f, with the upper 32 bits accessed via CSR registers 0xc80–0xc9f on RV32. The first three of these (CYCLE, TIME, and

INSTRET) have dedicated functions; while the remaining counters, if implemented, provide programmable event counting.

The E34 Core Complex implements `mcycle`, `mtime`, and `minstret` counters, which have dedicated functions: cycle count, real-time clock, and instructions-retired, respectively. The timer functionality is based on the `mtime` register. Additionally, the E34 Core Complex implements event counters in the form of `mhpmcounter`, which is used to monitor user requested events.

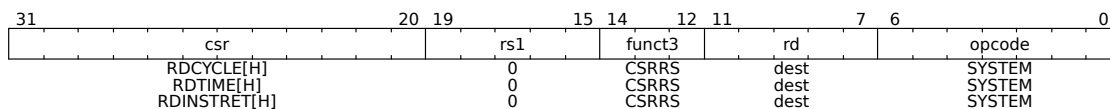

Figure 66: Timer and Counter Pseudoinstructions

Instruction	Description
RDCYCLE rd	Reads the low 32-bits of the cycle CSR which holds a count of the number of clock cycles executed by the processor core on which the hart is running from an arbitrary start time in the past.
RDCYCLEH rd	RV32I instruction that reads bits 63–32 of the same cycle counter.
RDTIME rd	Generates an illegal instruction exception. The <code>mtime</code> register is memory mapped to the CLINT register space and can be read using a regular load instruction.
RDTIMEH rd	RV32I-only instruction. Generates an illegal instruction exception. The <code>mtime</code> register is memory mapped to the CLINT register space and can be read using a regular load instruction.
RDINSTRET rd	Reads the low 32-bits of the instret CSR, which counts the number of instructions retired by this hart from some arbitrary start point in the past.
RDINSTRETH rd	RV32I-only instruction that reads bits 63–32 of the same instruction counter.

Table 62: Timer and Counter Pseudoinstruction Description

RDCYCLE, RDTIME, and RDINSTRET pseudoinstructions read the full 64 bits of the `cycle`, `time`, and `instret` counters. The RDCYCLE pseudoinstruction reads the low 32-bits of the cycle CSR (`mcycle`), which holds a count of the number of clock cycles executed by the processor core on which the hart is running from an arbitrary start time in the past. The RDTIME pseudoinstruction reads the low 32-bits of the time CSR (`mtime`), which counts wall-clock real time that has passed from an arbitrary start time in the past. The RDINSTRET pseudoinstruction reads the low 32-bits of the instret CSR (`minstret`), which counts the number of instructions retired by this hart from some arbitrary start point in the past. The rate at which the cycle counter advances is `rtc_clock`. To determine the current rate (cycles per second) of instruction execution, call the `metal_timer_get_timebase_frequency` API. The `metal_timer_get_timebase_frequency` and additional APIs are described in Section 5.8.2 below.

Number	Privilege	Name	Description
0xC00	RO	cycle	Cycle counter for RDCYCLE instruction
0xC01	RO	time	Timer for RDTIME instruction
0xC02	RO	instret	Instruction-retired counter for RDINSTRET instruction
0xC80	RO	cycleh	Upper 32 bits of cycle, RV32 only.
0xC81	RO	timeh	Upper 32 bits of time, RV32 only.
0xC82	RO	instreth	Upper 32 bits of instret, RV32 only

**Table 63:** Timer and Counter CSRs

### 5.8.1 Timer Register

`mtime` is a 64-bit read-write register that contains the number of cycles counted from the `rtc_toggle` signal described in the E34 Core Complex User Guide. On reset, `mtime` is cleared to zero.

### 5.8.2 Timer API

The APIs below are used for reading and manipulating the machine timer. Other APIs are described in more detail within the Freedom Metal documentation. <https://sifive.github.io/freedom-metal-docs/>

#### Functions

**`int meta_timer_get_cyclecount(int hartid, unsigned long long *cyclecount)`**

Read the machine cycle count.

#### Return

0 upon success

#### Parameters

- `hartid`: The hart ID to read the cycle count of
- `cyclecount`: The variable to hold the value

**`int meta_timer_get_timebase_frequency(int hartid, unsigned long long *timebase)`**

Get the machine timebase frequency.

#### Return

0 upon success

#### Parameters

- `hartid`: The hart ID to read the cycle count of
- `timebase`: The variable to hold the value

**`int meta_timer_set_tick(int hartid, int second)`**

Set the machine timer tick interval in seconds.

**Return**

0 upon success

**Parameters**

- `hartid`: The hart ID to read the cycle count of
- `second`: The number of seconds to set the tick interval to

## 5.9 Privileged Instructions

The RISC-V architecture implements privileged instructions that can only be executed when the E34 Core Complex is operating in a privileged mode. The SYSTEM major opcode is used to encode all of the privileged instructions.

### 5.9.1 Machine-Mode Privileged Instructions

#### Environment Call and Breakpoint

These ECALL and EBREAK instructions cause a precise requested trap to the supporting execution environment. The ECALL instruction is used to make a service request to the execution environment. The EBREAK instruction is used to return control to a debugging environment.

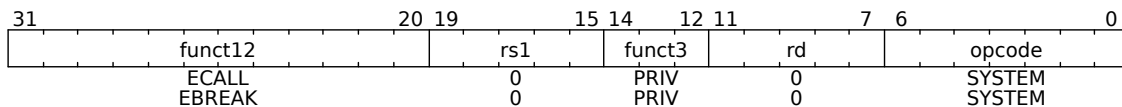

**Figure 67:** ECALL and EBREAK Instructions

#### Trap-Return Instructions

To return after handling a trap, there are separate trap return instructions per privilege level: MRET, SRET, and URET. MRET is always provided, while SRET must be provided if the respective privilege mode is supported. URET is only provided if user-mode traps are supported. An xRET instruction can be executed in privilege mode x or higher, where executing a lower-privilege xRET instruction will pop the relevant lower-privilege interrupt enable and privilege mode stack.

#### Wait for Interrupt

The Wait for Interrupt (WFI) instruction provides a hint to the E34 Core Complex that the current hart can be stalled until an interrupt might need servicing. Execution of the WFI instruction can also be used to inform the hardware platform that suitable interrupts should preferentially be routed to this hart.

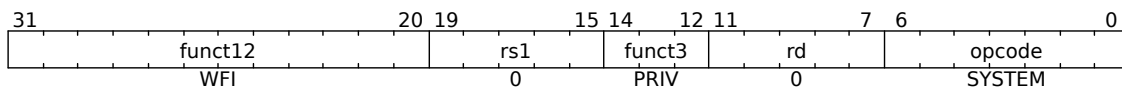

**Figure 68:** Wait for Interrupt Instruction

If an enabled interrupt is present or later becomes present while the hart is stalled, the interrupt exception will be taken on the following instruction, i.e., execution resumes in the trap handler and `mepc = pc + 4`. The WFI instruction can also be executed when interrupts are disabled. The operation of WFI must be unaffected by the global interrupt bits in `mstatus` (MIE/SIE/UIE) (i.e., the hart must resume if a locally enabled interrupt becomes pending), but should honor the individual interrupt enables (e.g, MTIE). WFI is also required to resume execution for locally enabled interrupts pending at any privilege level, regardless of the global interrupt enable at each privilege level. If the event that causes the hart to resume execution does not cause an interrupt to be taken, execution will resume at `pc + 4`, and software must determine what action to take, including looping back to repeat the WFI if there was no actionable event.

The suggested way to call WFI is inside an infinite loop as described below.

```
while (1) {  
    __asm__ volatile ("wfi");  
}
```

The WFI instruction is just a hint, and a legal implementation is to implement WFI as a NOP. In SiFive's implementation of WFI, the WFI instruction is issued and the core goes into internal clock gating state.

## 5.10 ABI - Register File Usage and Calling Conventions

RV32IMAFC has 32 x registers that are each 32 bits wide.

Register	ABI Name	Description	Saver
x0	zero	Hard-wired zero	-
x1	ra	Return address	Caller
x2	sp	Stack pointer	Callee
x3	gp	Global pointer	-
x4	tp	Thread pointer	-
x5	t0	Temporary / alternate link register	Caller
x6-7	t1-2	Temporaries	Caller
x8	s0/fp	Saved-register / frame-ponter	Callee
x9	s1	Saved register	Callee
x10-11	a0-1	Function arguments / return values	Caller
x12-17	a2-7	Function arguments	Caller
x18-27	s2-11	Saved registers	Callee
x28-31	t3-6	Temporaries	Caller
Floating-Point Registers			
f0-7	ft0-7	FP temporaries	Caller
f8-9	fs0-1	FP saved registers	Callee
f10-11	fa0-1	FP arguments / return values	Caller
f12-17	fa2-7	FP arguments	Caller
f18-27	fa2-11	FP saved registers	Callee
f28-31	ft8-11	FP temporaries	Caller

**Table 64:** RISC-V Registers

The programmer counter PC hold the address of the current instruction.

- x1 / ra - holds the return address for a call.
- x2 / sp - stack pointer, points to the current routine stack.
- x8 / fp / s0 - frame pointer, points to the bottom of the top stack frame.
- x3 / gp - global pointer, points into the middle of the global data section.  
 The common definition is: .data + 0x800. RISC-V immediate values are 12-bit signed values, which is +/- 2048 in decimal or +/- 0x800 in hex. So that global pointer relative accesses can reach their full extent, the global pointer point + 0x800 into the data section. The linker can then relax LUI+LW, LUI+SW into gp-relative LW or SW. i.e. shorter instruction sequences and access most global data using LW at gp +/- offset

```
LW t0 , 0x800(gp)
LW t1 , 0x7FF(gp)
```

- x4 / tp - thread pointer, point to thread-local storage (TLS-mostly used in linux and RTOS).  
 If you create a variable in TLS, every thread has its own copy of the variable, i.e. changes to the variable are local to the thread. This is a static area of memory that gets copied for each thread in a program. It is also used to create libraries that have thread-safe functions,



because of the fact that each call to a function has its copy of the same global data, so it's safe.

### 5.10.1 RISC-V Assembly

RISC-V instructions have opcodes and operands.

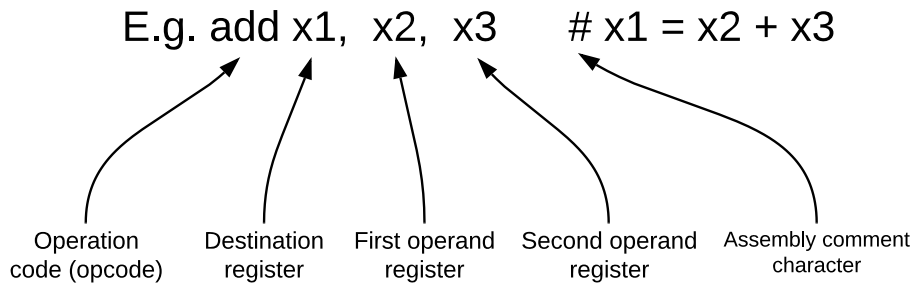

**Figure 69:** RISC-V Assembly Example

Assembly	C	Description
add x1, x2, x3	a = b + c	a=x1, b=x2, c=x3
sub x3, x4, x5	d = e - f	d=x3, e=x4, f=x5
add x0, x0, x0	NOP	Writes to x0 are always ignored
add x3, x4, x0	f = g	f=x3, g=x4
addi x3, x4, -10	f = g - 10	f=x3, g=x4
lw x10, 12(x13) # 12 = 3x4 add x11, x12, x10	int A[100]; g = h + A[3];	Reg x10 gets A[3] g=x11, h=x12
lw x10, 12(x13) # 12 = 3x4 add x10, x12, x10 sw x10, 40(x13) # 40 = 10x4	int A[100]; A[10] = h + A[3];	Reg x10 gets A[3] h=x12 Reg x10 gets h + A[3]
bne x13, x14, done add x10, x11, x12 done:	if (i == j) f = g + h;	f=x10, g=x11, h=x12, i=x13, j=x14
bne x10, x14, else add x10, x11, x12 j done else: sub x10, x11, x12 done:	if (i == j) f = g + h; else f = g - h;	f=x10, g=x11, h=x12, i=x13, j=x14

**Table 65:** RISC-V Assembly and C Examples

### 5.10.2 Assembler to Machine Code

The following flowchart describes how the assembler converts the RISC-V assembly code to machine code.

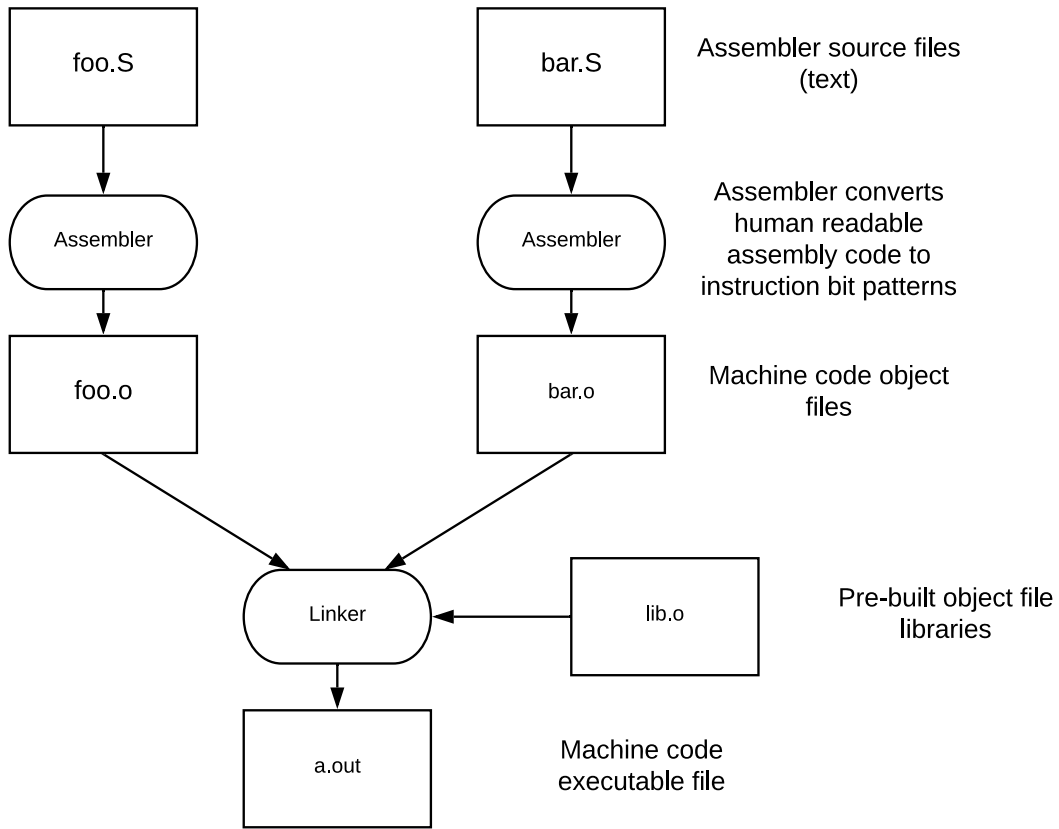

**Figure 70:** RISC-V Assembly to Machine Code

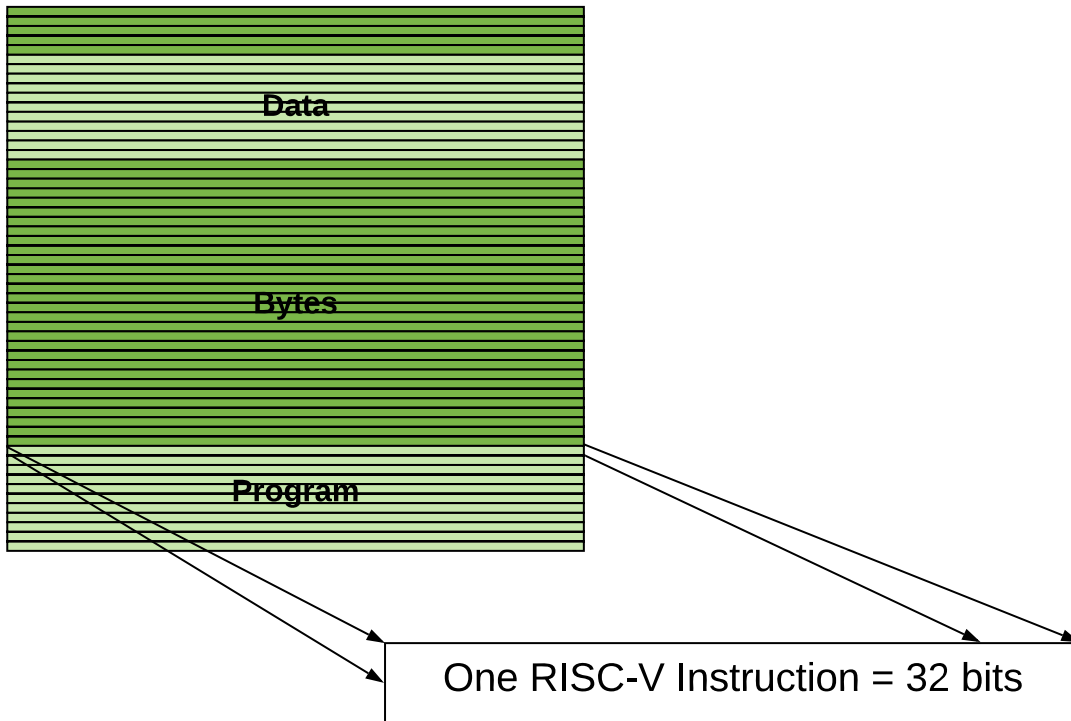

Figure 71: One RISC-V Instruction

### 5.10.3 Calling a Function (Calling Convention)

1. Put parameters in place where function can access them.
2. Transfer control to function.
3. Acquire local resources needed for function.
4. Perform function task.
5. Place result values where calling code can access and restore any registers might have used.
6. Return control to original caller.

Caller-saved The function invoked can do whatever it likes with the registers. Callee-saved If a function wants to use registers it needs to store and restore them.

Take, for example, the following function:

```
int leaf(int g, int h, int i, int j) {  
    int f;  
    f = (g+h) - (i+j);  
    return f;  
}
```

In this function above, arguments are passed in a0, a1, a2 and a3. The return value is returned in a0.

```
addi sp, sp, -8    # adjust stack for 2 items
sw s1, 4(sp)      # save s1 for use afterwards
sw s0, 0(sp)      # save s0 for use afterwards

add s0,a0,a1      # s0 = g + h
add s1,a2,a3      # s1 = i + j
sub a0,s0,s1      # return value (g + h) - (i + j)

lw s0, 0(sp)      # restore register s0 for caller
lw s1, 4(sp)      # restore register s1 for caller
addi s1, 4(sp)    # adjust stack to delete 2 items
jr ra             # jump back to calling routine
```

In the assembly above, notice that the stack pointer was decremented by 8 to make room to save the registers. Also, s1 and s0 are saved and will be stored at the end.

### Nested Functions

In the case of nested function calls, values held in a0-7 and ra will be clobbered.

Take, for example, the following function:

```
int sumSquare(int x, int y) {
    return mult(x,x) + y;
}
```

In the function above, a function called sumSquare is calling mult. To execute the function, there's a value in ra that sumSquare wants to jump back to, but this value will be overwritten by the call to mult.

To avoid this, the sumSquare return address must be saved before the call to mult. To save the the return address of sumSquare, the function can utilize stack memory. The user can use stack memory to preserve automatic (local) variables that don't fit within the registers.

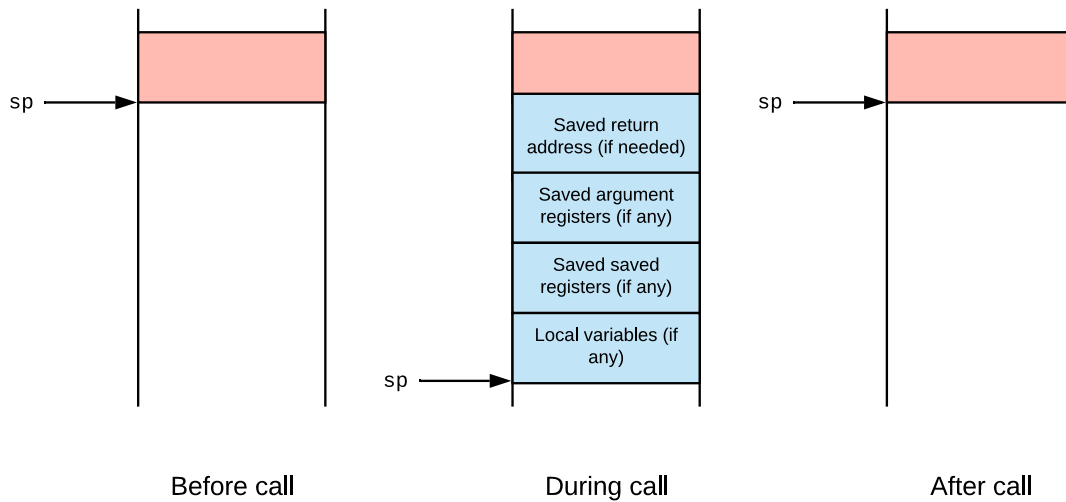

**Figure 72:** Stack Memory during Function Calls

Consider the assembly for sumSquare below:

```

sumSquare:
addi sp,sp,-8      # reserve space on stack
sw ra, 4(sp)      # save return address
sw a1, 0(sp)      # save y
mv a1,a0          # mult(x,x)
jal mult          # call mult
lw a1, 0(sp)      # restore y
add a0,a0,a1      # mult()+y
lw ra, 4(sp)      # get return address
addi sp,sp,8      # restore stack
mult:...
  
```

## Memory Layout

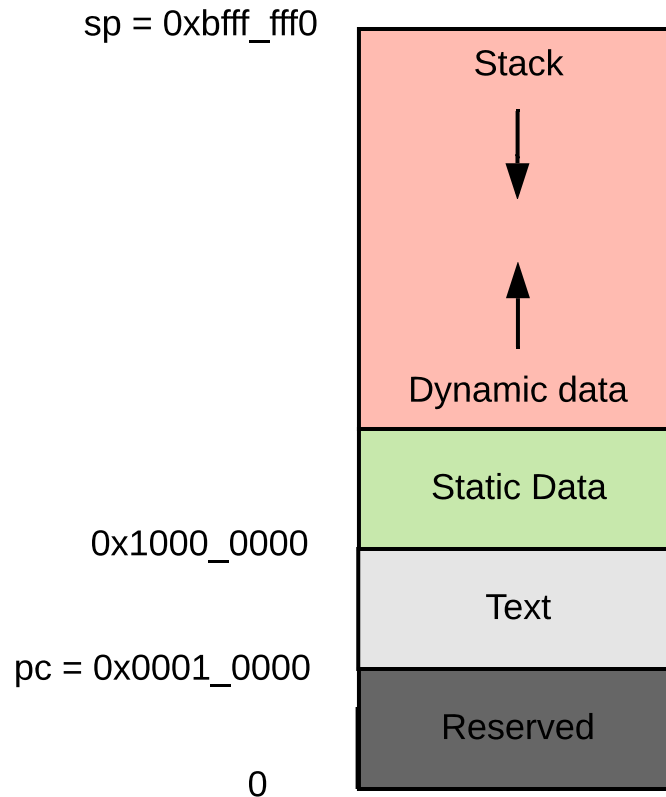

Figure 73: RV32 Memory Layout

## 5.11 Memory Ordering - FENCE Instructions

In the RISC-V ISA, each thread, referred to as a hart, observes its own memory operations as if they executed sequentially in program order. RISC-V also has a relaxed memory model, which requires explicit FENCE instructions to guarantee the ordering of memory operations.

The FENCE instructions include FENCE and FENCE . I. The FENCE instruction simply ensures that the memory access instructions before the FENCE instruction get committed before the FENCE instruction is committed. It does not guarantee that those memory access instructions have actually completed. For example, a load instruction before a FENCE instruction can commit without waiting for its value to come back from the memory system. FENCE . I functions the same as FENCE, as well as flushes the instruction cache.

**For example, without FENCE instructions:**

Hart 1 executes:

Load X  
Store Y  
Store Z

Because of relaxed memory model, Hart 2 could see stores/loads arranged in any order:

Store Z  
Load X  
Store Y

### With FENCE instructions:

Hart 1 executes:

Load X  
Store Y  
FENCE  
Store Z

Hart 2 sees:

Store Y  
Load X  
Store Z

With FENCE instructions, Hart 2 is forced to see the Load X and the Store Y prior to the Store Z, but could arbitrarily see Store Y before Load X or Load X before Store Y. Functionally, FENCE instructions order the completion of older memory accesses prior to newer accesses. However, unnecessary FENCE instructions slow processes and can hide bugs, so it is essential to identify where and when FENCE should be used.

## 5.12 Boot Flow

This process is managed as part of the Freedom Metal source code. The freedom-metal boot code supports single core boot or multi-core boot, and contains all the necessary initialization code to enable every core in the system.

1. ENTRY POINT: File: freedom-metal/src/entry.S, label: `_enter`.
2. Initialize global pointer `gp` register using the generated symbol `__global_pointer$`.
3. Write `mtvec` register with `early_trap_vector` as default exception handler.
4. Clear feature disable CSR `0x7c1`.
5. Read `mhartid` into register `a0` and call `_start`, which exists in `crt0.S`.
6. We now transition to File: freedom-metal/gloss/crt0.S, label: `_start`.
7. Initialize stack pointer, `sp`, with `_sp` generated symbol. Harts with `mhartid` of one or larger are offset by `(_sp + __stack_size × mhartid)`. The `__stack_size` field is generated in the linker file.

8. Check if `mhartid == __metal_boot_hart` and run the init code if they are equal. All other harts skip init and go to the Post-Init Flow, step #15.
9. Boot Hart Init Flow begins here.
10. Init data section to destination in defined RAM space.
11. Copy ITIM section, if ITIM code exists, to destination.
12. Zero out bss section.
13. Call `atexit` library function that registers the `libc` and `freedom-metal` destructors to run after `main` returns.
14. Call the `__libc_init_array` library function, which runs all functions marked with `__attribute__((constructor))`.
  - a. For example, PLL, UART, L2 if they exist in the design. This method provides full early initialization prior to entering the main application.
15. Post-Init Flow Begins Here.
16. Call the C routine `__metal_synchronize_harts`, where hart 0 will release all harts once their individual `msip` bits are set. The `msip` bit is typically used to assert a software interrupt on individual harts, however interrupts are not yet enabled, so `msip` in this case is used as a gatekeeping mechanism.
17. Check `misa` register to see if floating-point hardware is part of the design, and set up `mstatus` accordingly.
18. Single or multi-hart design redirection step.
  - a. If design is a single hart only, or a multi-hart design without a C-implemented function `secondary_main`, ONLY the boot hart will continue to `main()`.
  - b. For multi-hart designs, all other CPUs will enter sleep via WFI instruction via the weak `secondary_main` label in `cr0.S`, while boot hart runs the application program.
  - c. In a multi-hart design which includes a C-defined `secondary_main` function, all harts will enter `secondary_main` as the primary C function.

## 5.13 Linker File

The linker file generates important symbols that are used in the boot code. The linker file options are found in the `freedom-e-sdk/bsp` path.

There are usually three different linker file options:

- `metal.default.lds` — Use flash and RAM sections
- `metal.ramrodata.lds` — Place read only data in RAM for better performance
- `metal.scratchpad.lds` — Places all code + data sections into available RAM location



Each linker option can be selected by specifying LINK\_TARGET on the command line.

For example:

```
make PROGRAM=hello TARGET=design-rtl CONFIGURATION=release  
LINK_TARGET=scratchpadsoftware
```

The meta1.default.lids linker file is selected by default when LINK\_TARGET is not specified. If there is a scenario where a custom linker is required, one of the supplied linker files can be copied and renamed and used for the build. For example, if a new linker file named meta1.newmap.lids was generated, this can be used at build time by specifying LINK\_TARGET=newmap on the command line.

### 5.13.1 Linker File Symbols

The linker file generates symbols that are used by the startup code, so that software can use these symbols to assign the stack pointer, initialize or copy certain RAM sections, and provide the boot hart information. These symbols are made visible to software using the PROVIDE keyword.

For example:

```
__stack_size = DEFINED(__stack_size) ? __stack_size : 0x400;  
PROVIDE(__stack_size = __stack_size);
```

#### Generated Linker Symbols

A description list of the generated linker symbols is shown below.

##### \_\_metal\_boot\_hart

This is an integer number to describe which hart runs the main init flow. The mhartid CSR contains the integer value for each hart. For example, hart 0 has mhartid==0, hart 1 has mhartid==1, and so on. An assembly example is shown below, where a0 already contains the mhartid value.

```
/* If we're not hart 0, skip the initialization work */  
la t0, __metal_boot_hart  
bne a0, t0, _skip_init
```

An example on how to use this symbol in C code is shown below.

```
extern int __metal_boot_hart;  
int boot_hart = (int)&__metal_boot_hart;
```

Additional linker file generated symbols, along with descriptions are shown below.

##### \_\_metal\_chicken\_bit

Status bit to tell startup code to zero out the Feature Disable CSR. Details of this register are internal use only.

### **\_\_global\_pointer\$**

Static value used to write the gp register at startup.

### **\_sp**

Address of the end of stack for hart 0, used to initialize the beginning of the stack since the stack grows lower in memory. On a multi-hart system, the start address of the stack for each hart is calculated using  $(\_sp + \_stack\_size \times mhartid)$

### **metal\_segment\_bss\_target\_start**

### **metal\_segment\_bss\_target\_end**

Used to zero out global data mapped to .bss section.

- Only `__metal_boot_hart` runs this code.

### **metal\_segment\_data\_source\_start**

### **metal\_segment\_data\_target\_start**

### **metal\_segment\_data\_target\_end**

Used to copy data from image to its destination in RAM.

- Only `__metal_boot_hart` runs this code.

### **metal\_segment\_itim\_source\_start**

### **metal\_segment\_itim\_target\_start**

### **metal\_segment\_itim\_target\_end**

Code or data can be placed in itim sections using the `__attribute__((section(".itim")))`.

- When this attribute is applied to code or data, the `metal_segment_itim_source_start`, `metal_segment_itim_target_start`, and `metal_segment_itim_target_end` symbols get updated accordingly, and these symbols allow the startup code to copy code and data into the ITIM area.
  - Only `__metal_boot_hart` runs this code.

#### **Note**

At the time of this writing, the boot flow does not support C++ projects

## **5.14 RISC-V Compiler Flags**

### **5.14.1 arch, abi, and mtune**

RISC-V targets are described using three arguments:

1. `-march=ISA`: selects the architecture to target.

2. `-mabi=ABI`: selects the ABI to target.
3. `-mtune=CODENAME`: selects the microarchitecture to target.

**-march**

This argument controls which instructions and registers are available for the compiler, as defined by the RISC-V user-level ISA specification.

The RISC-V ISA with 32, 32-bit integer registers and the instructions for multiplication would be denoted as RV32IM. Users can control the set of instructions that GCC uses when generating assembly code by passing the lower-case ISA string to the `-march` GCC argument: for example `-march=rv32im`. On RISC-V systems that don't support particular operations, emulation routines may be used to provide the missing functionality.

Example:

```
double dmul(double a, double b) {
    return a * b;
}
```

will compile directly to a FP multiplication instruction when compiled with the D extension:

```
$ riscv64-unknown-elf-gcc test.c -march=rv64imafdc -mabi=lp64d -o- -S -O3
dmul:
    fmul.d   fa0,fa0,fa1
    ret
```

but will compile to an emulation routine without the D extension:

```
$ riscv64-unknown-elf-gcc test.c -march=rv64i -mabi=lp64 -o- -S -O3
dmul:
    add     sp,sp,-16
    sd     ra,8(sp)
    call   __muldf3
    ld     ra,8(sp)
    add     sp,sp,16
    jr     ra
```

Similar emulation routines exist for the C intrinsics that are trivially implemented by the M and F extensions.

**-mabi**

`-mabi` selects the ABI to target. This controls the calling convention (which arguments are passed in which registers) and the layout of data in memory. The `-mabi` argument to GCC specifies both the integer and floating-point ABIs to which the generated code complies. Much like how the `-march` argument specifies which hardware generated code can run on, the `-mabi` argument specifies which software-generated code can link against. We use the standard naming scheme for integer ABIs (`i1p32` or `lp64`), with an argumental single letter appended to

select the floating-point registers used by the ABI (`ilp32` vs. `ilp32f` vs. `ilp32d`). In order for objects to be linked together, they must follow the same ABI.

RISC-V defines two integer ABIs and three floating-point ABIs.

- `ilp32`: `int`, `long`, and pointers are all 32-bits long. `long long` is a 64-bit type, `char` is 8-bit, and `short` is 16-bit.
- `lp64`: `long` and pointers are 64-bits long, while `int` is a 32-bit type. The other types remain the same as `ilp32`.

The floating-point ABIs are a RISC-V specific addition:

- `""` (the empty string): No floating-point arguments are passed in registers.
- `f`: 32-bit and smaller floating-point arguments are passed in registers. This ABI requires the F extension, as without F there are no floating-point registers.
- `d`: 64-bit and smaller floating-point arguments are passed in registers. This ABI requires the D extension.

#### arch/abi Combinations

- `march=rv32imafdc -mabi=ilp32d`: Hardware floating-point instructions can be generated and floating-point arguments are passed in registers. This is like the `-mfloat-abi=hard` argument to ARM's GCC.
- `march=rv32imac -mabi=ilp32`: No floating-point instructions can be generated and no floating-point arguments are passed in registers. This is like the `-mfloat-abi=soft` argument to ARM's GCC.
- `march=rv32imafdc -mabi=ilp32`: Hardware floating-point instructions can be generated, but no floating-point arguments will be passed in registers. This is like the `-mfloat-abi=softfp` argument to ARM's GCC, and is usually used when interfacing with soft-float binaries on a hard-float system.
- `march=rv32imac -mabi=ilp32d`: Illegal, as the ABI requires floating-point arguments are passed in registers but the ISA defines no floating-point registers to pass them in.

Example:

```
double dmul(double a, double b) {
    return b * a;
}
```

If neither the ABI or ISA contains the concept of floating-point hardware then the C compiler cannot emit any floating-point-specific instructions. In this case, emulation routines are used to perform the computation and the arguments are passed in integer registers:

```
$ riscv64-unknown-elf-gcc test.c -march=rv32imac -mabi=ilp32 -o- -S -O3
dmul:
    mv      a4,a2
```

```
mv    a5,a3
add   sp,sp,-16
mv    a2,a0
mv    a3,a1
mv    a0,a4
mv    a1,a5
sw    ra,12(sp)
call  __muldf3
lw    ra,12(sp)
add   sp,sp,16
jr    ra
```

The second case is the exact opposite of this one: everything is supported in hardware. In this case we can emit a single `fmul.d` instruction to perform the computation.

```
$ riscv64-unknown-elf-gcc test.c -march=rv32imafdc -mabi=ilp32d -o- -S -03
dmul:
    fmul.d  fa0,fa1,fa0
    ret
```

The third combination is for users who may want to generate code that can be linked with code designed for systems that don't subsume a particular extension while still taking advantage of the extra instructions present in a particular extension. This is a common problem when dealing with legacy libraries that need to be integrated into newer systems. For this purpose the compiler arguments and multilib paths designed to cleanly integrate with this workflow. The generated code is essentially a mix between the two above outputs: the arguments are passed in the registers specified by the `ilp32` ABI (as opposed to the `ilp32d` ABI, which could pass these arguments in registers) but then once inside the function the compiler is free to use the full power of the RV32IMAFDC ISA to actually compute the result. While this is less efficient than the code the compiler could generate if it was allowed to take full advantage of the D-extension registers, it's a lot more efficient than computing the floating-point multiplication without the D-extension instructions

```
$ riscv64-unknown-elf-gcc test.c -march=rv32imafdc -mabi=ilp32 -o- -S -03
dmul:
    add    sp,sp,-16
    sw    a0,8(sp)
    sw    a1,12(sp)
    fld   fa5,8(sp)
    sw    a2,8(sp)
    sw    a3,12(sp)
    fld   fa4,8(sp)
    fmul.d fa5,fa5,fa4
    fsd   fa5,8(sp)
    lw    a0,8(sp)
    lw    a1,12(sp)
    add   sp,sp,16
    jr    ra
```

## 5.15 Compilation Process

GCC driver script is actually running the preprocessor, then the compiler, then the assembler and finally the linker. If the user runs GCC with the `--save-temps` argument, several intermediate files will be generated.

```
$ riscv64-unknown-linux-gnu-gcc relocation.c -o relocation -O3 --save-temps
```

- `relocation.i`: The preprocessed source, which expands any preprocessor directives (things like `#include` or `#ifdef`).
- `relocation.s`: The output of the actual compiler, which is an assembly file (a text file in the RISC-V assembly format).
- `relocation.o`: The output of the assembler, which is an un-linked object file (an ELF file, but not an executable ELF).
- `relocation`: The output of the linker, which is a linked executable (an executable ELF file).

## 5.16 Large Code Model Workarounds

RISC-V software currently requires that linked symbols reside within a 32-bit range. There are two types of code models defined for RISC-V, **medlow** and **medany**. The **medany** code model generates `auipc/ld` pairs to refer to global symbols, which allows the code to be linked at any address, while **medlow** generates `lui/ld` pairs to refer to global symbols, which restricts the code to be linked around address zero. They both generate 32-bit signed offsets for referring to symbols, so they both restrict the generated code to being linked within a 2 GiB window. When building software, the code model parameter is passed into the RISC-V toolchain and it defines a method to generate the necessary instruction combinations to access global symbols within the software program. This is done using `-mcode1=medany/medlow`. For 32-bit architectures, we use the **medlow** code model, while **medany** is used for 64-bit architectures. This is controlled within the 'setting.mk' file in the `freedom-e-sdk/bsp` folder.

The real problem occurs when:

1. Total program size exceeds 2 GiB, which is rare
2. When global symbols within a single compiled image are required to reside in a region outside of the 32-bit space

Example for symbols within 32-bit address space:

```
MEMORY
{
ram (wxa!ri) : ORIGIN = 0x80000000, LENGTH = 0x4000
flash (rxai!w) : ORIGIN = 0x20400000, LENGTH = 0x1fc00000
}
```

Example for symbols outside 32-bit address space:

```
MEMORY
```

```
{
ram (wxa!ri) : ORIGIN = 0x100000000, LENGTH = 0x4000 /* Updated ORIGIN from
0x80000000 */
flash (rxai!w) : ORIGIN = 0x20400000, LENGTH = 0x1fc00000
}
```

If a software example uses the above memory map, and uses either medlow or medany code models, it will not link successfully. Generated errors will generally contain the following phrase:

relocation truncated to fit:

### 5.16.1 Workaround Example #1

Even if global symbols cannot be linked with the toolchain, we can still access any 64-bit addressable space using pointers. The following example is a straightforward approach to accessing data within any 64-bit addressable space:

```
// Create defines for new memory region
#define LARGE_DATA_SECTION_ADDRESS 0x100000000
#define LARGE_DATA_SECTION_SIZE_IN_BYTES 0x4000
#define DWORD_SIZE 8

int main(void) {

/*****
/* Example #1 - defining and accessing data outside 32-bit range using array
pointer */

*****/

uint32_t idx;
uint64_t *data_array, addr;

data_array = (uint64_t *)LARGE_DATA_SECTION_ADDRESS;
for (addr = 0, idx = 0; addr < LARGE_DATA_SECTION_SIZE_IN_BYTES; addr +=
DWORD_SIZE, idx++) {

// Simply writing data to our region outside of 32-bit range
data_array[idx] = addr;
}
}
```

### 5.16.2 Workaround Example #2

Here we use an existing freedom-metal data structure to define a new region and API to access attributes of the region.

```
#include <metal/memory.h> // required for data struct

// Create defines for new memory region
#define LARGE_DATA_SECTION_ADDRESS 0x100000000
#define LARGE_DATA_SECTION_SIZE_IN_BYTES 0x4000
#define DWORD_SIZE 8

// Create our struct using existing metal_memory type in freedom-metal
```

```
const struct metal_memory large_data_mem_struct;
const struct metal_memory large_data_mem_struct = {
    ._base_address = LARGE_DATA_SECTION_ADDRESS,
    ._size = LARGE_DATA_SECTION_SIZE_IN_BYTES,
    ._attrs = {.R = 1, .W = 1, .X = 0, .C = 1, .A = 0},
};

int main(void) {
    // Example #2 - Creating data structure which defines 64-bit addressable regions,
    // using existing structure type to define base addr, size, and permissions

    size_t _large_data_size;
    uintptr_t _large_data_base_addr;
    int _atomics_enabled, _cachable_enabled;
    uint64_t *large_data_array;

    _large_data_base_addr = metal_memory_get_base_address(&large_data_mem_struct);
    _large_data_size = metal_memory_get_size(&large_data_mem_struct);
    _atomics_enabled = metal_memory_supports_atomics(&large_data_mem_struct);
    _cachable_enabled = metal_memory_is_cachable(&large_data_mem_struct);

    large_data_array = (uint64_t *)_large_data_base_addr;

    // Access our new memory region
    // large_data_array[x] = 0x0;
    // ... add functional code ...

    return 0;
}
```

This example can be used if multiple data regions are required with different attributes. Once the base address is assigned from the required data structure, then pointers can be used to access memory, similar to Example #1 above. The existing struct and API format allows for multiple regions to be created easily.

## 5.17 Pipeline Hazards

The pipeline only interlocks on read-after-write and write-after-write hazards, so instructions may be scheduled to avoid stalls.

### 5.17.1 Read-After-Write Hazards

Read-after-Write (RAW) hazards occur when an instruction tries to read a register before a preceding instruction tries to write to it. This hazard describes a situation where an instruction refers to a result that has not been calculated or retrieved. This situation is possible because even though an instruction was executed after a prior instruction, the prior instruction may only have processed partly through the core pipeline.

Example:

- Instruction 1:  $x1 + x3$  is saved in  $x2$



- Instruction 2:  $x2 + x3$  is saved in  $x4$

The first instruction is calculating a value ( $x1 + x3$ ) to be saved in  $x2$ . The second instruction is going to use the value of  $x2$  to compute a result to be saved in  $x4$ . However, in the core pipeline, when operations are fetched for the second operation, the results from the first operation have not yet been saved.

### 5.17.2 Write-After-Write Hazards

Write-after-write (WAW) hazards occur when an instruction tries to write an operand before it is written by a preceding instruction.

Example:

- Instruction 1:  $x4 + x7$  is saved in  $x2$
- Instruction 2:  $x1 + x3$  is saved in  $x2$

Write-back of instruction 2 must be delayed until instruction 1 finishes executing.

In general, MMIO accesses stall when there is a hazard on the result caused by either RAW or WAW. So, instructions may be scheduled to avoid stalls.

## 5.18 Reading CSRs

There are several methods for reading the CSRs that are implemented in the E34 Core Complex. A full list of the defined RISC-V CSRs are described in Section 5.7.2.

1. Inline assembly using `csrr` instruction and the register name. For example, reading the `misa` CSR:

```
int misa;  
__asm__ volatile("csrr %0, misa" : "=r" (misa));
```

2. Using the Freedom Metal API `METAL_CPU_GET_CSR`. Again, reading the `misa` CSR:

```
int misa_value;  
METAL_CPU_GET_CSR(misa, misa_value);
```

In the second method, the first argument is the register name and the second is the variable to store the result in.

Both inline assembly and Freedom Metal API methods can receive the CSR number instead of its name. For example:

```
int mscratch;  
METAL_CPU_GET_CSR(0x340, mscratch_value); // reading mscratch csr
```

**Note**

Accessing CSRs has to be according to the privilege level you are in. Attempting to access a CSR in a privilege level higher than the current level of operation will result in an exception.

To access a privileged CSR, the user must switch to the appropriate privilege level. This can be done using the following Freedom Metal API:

```
metal_privilege_drop_to_mode(METAL_PRIVILEGE_USER,  
                             my_regfile,  
                             user_mode_entry_point);
```

The Freedom Metal API routines and more examples located in `freedom-e-sdk/software` directory.

## Chapter 6

# Custom Instructions and CSRs

These custom instructions use the SYSTEM instruction encoding space, which is the same as the custom CSR encoding space, but with `funct3=0`.

### 6.1 CEASE

- Privileged instruction only available in M-mode.
- Opcode `0x30500073`.
- After retiring CEASE, hart will not retire another instruction until reset.
- Instigates power-down sequence, which will eventually raise the `cease_from_tile_x` signal to the outside of the Core Complex, indicating that it is safe to power down.

### 6.2 PAUSE

- Opcode `0x0100000F`, which is a FENCE instruction with predecessor set W and null successor set. Therefore, PAUSE is a HINT instruction that executes as a no-op on all RISC-V implementations.
- This instruction may be used for more efficient idling in spin-wait loops.
- This instruction causes a stall of up to 32 cycles or until a cache eviction occurs, whichever comes first.

### 6.3 Branch Prediction Mode CSR

This SiFive custom extension adds an M-mode CSR to control the current branch prediction mode, `bpm` at CSR `0x7C0`.

The E34 Core Complex's branch prediction system includes a Return Address Stack (RAS), a Branch Target Buffer (BTB), and a Branch History Table (BHT). While branch predictors are essential to achieve high performance in pipelined processors, they can also cause undesirable timing variability for hard real-time systems. The `bpm` register provides a means to customize the branch predictor behavior to trade average performance for a more predictable execution time.

The bpm CSR has a single, one bit field defined: Branch-Direction Prediction (bdp).

### 6.3.1 Branch-Direction Prediction

The **WARL** bdp field determines the value returned by the BHT component of the branch prediction system. A zero value indicates dynamic direction prediction and a non-zero value indicates static-taken direction prediction. The BTB is cleared on any write to the bdp field and the RAS is unaffected by writes to the bdp field.

## 6.4 SiFive Feature Disable CSR

The SiFive custom M-mode Feature Disable CSR is provided to enable or disable certain microarchitectural features. In the E34 Core Complex, CSR 0x7c1 has been allocated for this purpose. These features are described in Table 66.

### Warning

The features that can be controlled by this CSR are subject to change or removal in future releases. It is not advised to depend on this CSR for development.

A feature is fully enabled when the associated bit is zero. If a particular core does not support the disabling of a feature, the corresponding bit is hardwired to zero.

On reset, all implemented bits are set to 1, disabling all features. The bootloader is responsible for turning on all required features, and can simply write zero to turn on the maximal set of features. SiFive's Freedom Metal bootloader handles turning on these features; when using a custom bootloader, clearing the Feature Disable CSR must be implemented.

Note that arbitrary toggling of the Feature Disable CSR bits is neither recommended nor supported; they are only intended to be set from 1 to 0. A particular Feature Disable CSR bit is only to be used in a very limited number of situations, as detailed in the **Example Usage** entry in Table 67.

Feature Disable CSR	
CSR	0x7C1
Bit	Description
0	Disable data cache clock gating
1	Disable instruction cache clock gating
2	Disable pipeline clock gating
3	Disable speculative instruction cache refill
[8:4]	Reserved
9	Suppress corrupt signal on GrantData messages
[16:10]	Reserved
17	Disable instruction cache next-line prefetcher
[31:18]	Reserved

Table 66: SiFive Feature Disable CSR

Feature Disable CSR Usage	
Bit	Description / Usage
3	Disable speculative instruction cache refill  <b>Example Usage:</b> A particular integration might require that execution from the System Port range be disallowed. Startup code would first configure PMP to prevent execution from the System Port range, followed by clearing bit 3 of the Feature Disable CSR. This would enable speculative instruction cache refill accesses, without allowing those to access the System Port range because PMP would prohibit such accesses.
9	Suppress corrupt signal on GrantData messages  <b>Example Usage 1:</b> When running in debug mode on configurations having both ECC and a BEU, setting bit 9 of the Feature Disable CSR will suppress debug mode errors. <b>Example Usage 2:</b> Startup code could scrub errors present in RAMs at power-on, followed by clearing bit 9 of the Feature Disable CSR to allow normal operation.

Table 67: SiFive Feature Disable CSR Usage

## 6.5 Other Custom Instructions

Other custom instructions may be implemented, but their functionality is not documented further here and they should not be used in this version of the E34 Core Complex.

## Chapter 7

# Interrupts and Exceptions

This chapter describes how interrupt and exception concepts in the RISC-V architecture apply to the E34 Core Complex.

### 7.1 Interrupt Concepts

Interrupts are *asynchronous* events that cause program execution to change to a specific location in the software application to handle the interrupting event. When processing of the interrupt is complete, program execution resumes back to the original program execution location. For example, a timer that triggers every 10 milliseconds will cause the CPU to branch to the interrupt handler, acknowledge the interrupt, and set the next 10 millisecond interval.

The E34 Core Complex supports machine mode interrupts.

The Core Complex also has support for the following types of RISC-V interrupts: local and global. Local interrupts are signaled directly to an individual hart with a dedicated interrupt exception code and fixed priority. This allows for reduced interrupt latency as no arbitration is required to determine which hart will service a given request and no additional memory accesses are required to determine the cause of the interrupt. Software and timer interrupts are local interrupts generated by the Core-Local Interruptor (CLINT).

Global interrupts are routed through a Platform-Level Interrupt Controller (PLIC), which can direct interrupts to any hart in the system via the external interrupt. Decoupling global interrupts from the hart allows the design of the PLIC to be tailored to the platform, permitting a broad range of attributes like the number of interrupts and the prioritization and routing schemes.

Chapter 8 describes the CLINT. Chapter 9 describes the global interrupt architecture and the PLIC design.

### 7.2 Exception Concepts

Exceptions are different from interrupts in that they typically occur *synchronously* to the instruction execution flow, and most often are the result of an unexpected event that results in the program to enter an exception handler. For example, if a hart is operating in supervisor mode and attempts to access a machine mode only Control and Status Register (CSR), it will immediately enter the exception handler and determine the next course of action. The exception code in the

mstatus register will hold a value of 0x2, showing that an illegal instruction exception occurred. Based on the requirements of the system, the supervisor mode application may report an error and/or terminate the program entirely.

There are no specific enable bits to allow exceptions to occur since they are always enabled by default. However, early in the boot flow, software should set up mtvec.BASE to a defined value, which contains the base address of the default exception handler. All exceptions will trap to mtvec.BASE. Software must read the mcause CSR to determine the source of the exception, and take appropriate action.

Synchronous exceptions that occur from within an interrupt handler will immediately cause program execution to abort the interrupt handler and enter the exception handler. Exceptions within an interrupt handler are usually the result of a software bug and should generally be avoided since mepc and mcause CSRs will be overwritten from the values captured in the original interrupt context.

The RISC-V defined synchronous exceptions have a priority order which may need to be considered when multiple exceptions occur simultaneously from a single instruction. Table 68 describes the synchronous exception priority order.

Priority	Interrupt Exception Code	Description
<i>Highest</i>	3	Instruction Address Breakpoint
	12	Instruction page fault
	1	Instruction access fault
	2	Illegal instruction
	0	Instruction address misaligned
	8, 9, 11	Environment call
	3	Environment break
	3	Load/Store/AMO address breakpoint
	6	Store/AMO address misaligned
	4	Load address misaligned
	15	Store/AMO page fault
<i>Lowest</i>	13	Load page fault
	7	Store/AMO access fault
	5	Load access fault

**Table 68:** Exception Priority

Refer to Table 76 for the full table of interrupt exception codes.

Data address breakpoints (watchpoints), Instruction address breakpoints, and environment break exceptions (EBREAK) all have the same Exception code (3), but different priority, as shown in the table above.

Instruction address misaligned exceptions (0x0) have lower priority than other instruction address exceptions because they are the result of control-flow instructions with misaligned targets, rather than from instruction fetch.

Some of the helpful CSRs for debugging exceptions and interrupts are described below:

CSR	Description
exception	SiFive Scope signal. Indicates the moment that an exception occurs in the write-back (commit) stage.
mcause	Contains the cause value of the exception/interrupt. See Section 7.7.5 for more description.
mepc	Contains the pc where the exception occurs.
mtval	If the cause is a load/store fault, this register has the value of the problematic address. If it is an invalid instruction, it provides the instruction that the core tried to execute.
mstatus	Contains the interrupt enables, privilege modes, and general status of execution. See Section 7.7.1 for more description.
mtvec	Contains the vector that the core will jump to when an exception occurs. If this is not a valid executable value, you may get a double-exception when jumping to the exception handler, so it is important to look at all these registers when the exception FIRST occurs. See Section 7.7.2 for more description.

**Table 69:** Summary of Exception and Interrupt CSRs

## 7.3 Trap Concepts

The term trap describes the transfer of control in a software application, where trap handling typically executes in a more privileged environment. For example, a particular hart contains three privilege modes: machine, supervisor, and user. Each privilege mode has its own software execution environment including a dedicated stack area. Additionally, each privilege mode contains separate control and status registers (CSRs) for trap handling. While operating in User mode, a context switch is required to handle an event in Supervisor mode. The software sets up the system for a context switch, and then an ECALL instruction is executed which synchronously switches control to the Environment call-from-User mode exception handler.

The default mode out of reset is Machine mode. Software begins execution at the highest privilege level, which allows all CSRs and system resources to be initialized before any privilege level changes. The steps below describe the required steps necessary to change privilege mode from machine to user mode, on a particular design that also includes supervisor mode.

1. Interrupts should first be disabled globally by writing `mstatus.MIE` to 0, which is the default reset value.
2. Write `mtvec` CSR with the base address of the Machine mode exception handler. This is a required step in any boot flow.
3. Write `mstatus.MPP` to 0 to set the previous mode to User which allows us to *return* to that mode.



4. Setup the Physical Memory Protection (PMP) regions to grant the required regions to user and supervisor mode, and optionally, revoke permissions from machine mode.
5. Write `stvec` CSR with the base address of the supervisor mode exception handler.
6. Write `medeleg` register to delegate exceptions to supervisor mode. Consider ECALL and page fault exceptions.
7. Write `mstatus.FS` to enable floating point (if supported).
8. Store machine mode user registers to stack or to an application specific frame pointer.
9. Write `mepc` with the entry point of user mode software
10. Execute `mret` instruction to enter user Mode.

### Note

There is only one set of user registers (x1 - x31) that are used across all privilege levels, so application software is responsible for saving and restoring state when entering and exiting different levels.

## 7.4 Interrupt Block Diagram

The E34 Core Complex interrupt architecture is depicted in Figure 74.

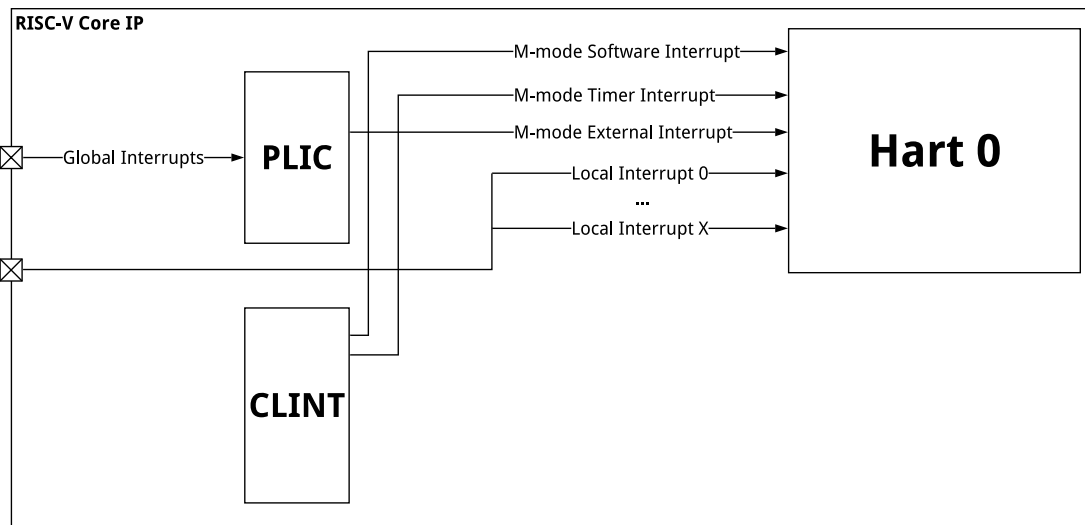

Figure 74: E34 Core Complex Interrupt Architecture Block Diagram

## 7.5 Local Interrupts

Software interrupts (Interrupt ID #3) are triggered by writing the memory-mapped interrupt pending register `msip` for a particular hart. The `msip` register is described in Table 74.

Timer interrupts (Interrupt ID #7) are triggered when the memory-mapped register `mtime` is greater than or equal to the global timebase register `mtimecmp`, and both registers are part of the CLINT memory map. The `mtime` and `mtimecmp` registers are generally only available in machine mode, unless the PMP grants user mode access to the memory-mapped region in which they reside.

Global interrupts are usually first routed to the PLIC, then into the hart using external interrupts (Interrupt ID #11).

Local external interrupts (Interrupt ID #16–31) may connect directly to an interrupt source, and do not need to be routed through the PLIC. The E34 Core Complex has 16 local external interrupts.

## 7.6 Interrupt Operation

If the global interrupt-enable `mstatus.MIE` is clear, then no interrupts will be taken. If `mstatus.MIE` is set, then pending-enabled interrupts at a higher interrupt level will preempt current execution and run the interrupt handler for the higher interrupt level.

When an interrupt or synchronous exception is taken, the privilege mode is modified to reflect the new privilege mode. The global interrupt-enable bit of the handler's privilege mode is cleared.

### 7.6.1 Interrupt Entry and Exit

When an interrupt occurs:

- The value of `mstatus.MIE` is copied into `mcause.MPIE`, and then `mstatus.MIE` is cleared, effectively disabling interrupts.
- The privilege mode prior to the interrupt is encoded in `mstatus.MPP`.
- The current `pc` is copied into the `mepc` register, and then `pc` is set to the value specified by `mtvec` as defined by the `mtvec.MODE` described in Table 72.

At this point, control is handed over to software in the interrupt handler with interrupts disabled. When an `mret` instruction is executed, the following occurs:

- The privilege mode is set to the value encoded in `mstatus.MPP`.
- The global interrupt enable, `mstatus.MIE`, is set to the value of `mcause.MPIE`.
- The `pc` is set to the value of `mepc`.

At this point, control is handed over to software.

At the software level, interrupt attributes can be applied to interrupt processing functions, as described in Section 8.4.

The Control and Status Registers (CSRs) involved in handling RISC-V interrupts are described in Section 7.7.

## 7.7 Interrupt Control and Status Registers

The E34 Core Complex specific implementation of interrupt CSRs is described below. For a complete description of RISC-V interrupt behavior and how to access CSRs, please consult *The RISC-V Instruction Set Manual, Volume II: Privileged Architecture, Version 1.10*.

### 7.7.1 Machine Status Register (mstatus)

The mstatus register keeps track of and controls the hart's current operating state, including whether or not interrupts are enabled. A summary of the mstatus fields related to interrupts in the E34 Core Complex is provided in Table 70. Note that this is not a complete description of mstatus as it contains fields unrelated to interrupts. For the full description of mstatus, please consult *The RISC-V Instruction Set Manual, Volume II: Privileged Architecture, Version 1.10*.

Machine Status Register (mstatus)			
CSR	0x300		
Bits	Field Name	Attr.	Description
[2:0]	Reserved	WPRI	
3	MIE	RW	Machine Interrupt Enable
[6:4]	Reserved	WPRI	
7	MPIE	RW	Machine Previous Interrupt Enable
[10:8]	Reserved	WPRI	
[12:11]	MPP	RW	Machine Previous Privilege Mode

**Table 70:** Machine Status Register (partial)

Interrupts are enabled by setting the MIE bit in mstatus. Prior to writing mstatus.MIE=1, it is recommended to first enable interrupts in mie.

### 7.7.2 Machine Trap Vector (mtvec)

The mtvec register has two main functions: defining the base address of the trap vector, and setting the mode by which the E34 Core Complex will process interrupts. For Direct and Vectored modes, the interrupt processing mode is defined in the MODE field of the mtvec register. The mtvec register is described in Table 71, and the mtvec.MODE field is described in Table 72.

Machine Trap Vector Register (mtvec)			
CSR	0x305		
Bits	Field Name	Attr.	Description
[1:0]	MODE	WARL	MODE Sets the interrupt processing mode. The encoding for the E34 Core Complex supported modes is described in Table 72.
[31:2]	BASE[31:2]	WARL	Interrupt Vector Base Address.  Operating in Direct Mode requires 4-byte alignment.  Operating in Vectored Mode requires 128-byte alignment.

**Table 71:** Machine Trap Vector Register

MODE Field Encoding mtvec.MODE		
Value	Mode	Description
0x0	Direct	All asynchronous interrupts and synchronous exceptions set pc to BASE.
0x1	Vectored	Exceptions set pc to BASE, interrupts set pc to BASE + 4 × mcause.EXCCODE.
≥0x2	Reserved	

**Table 72:** Encoding of mtvec.MODE

### Mode Direct

When operating in direct mode, all interrupts and exceptions trap to the mtvec.BASE address. Inside the trap handler, software must read the mcause register to determine what triggered the trap. The mcause register is described in Table 75.

When operating in Direct Mode, BASE must be 4-byte aligned.

### Mode Vectored

While operating in vectored mode, interrupts set the pc to mtvec.BASE + 4 × exception code (mcause.EXCCODE). For example, if a machine timer interrupt is taken, the pc is set to mtvec.BASE + 0x1C. Typically, the trap vector table is populated with jump instructions to transfer control to interrupt-specific trap handlers.

In vectored interrupt mode, BASE must be 128-byte aligned.

All machine external interrupts (global interrupts) are mapped to exception code 11. Thus, when interrupt vectoring is enabled, the pc is set to address mtvec.BASE + 0x2C for any global interrupt.

### 7.7.3 Machine Interrupt Enable (mie)

Individual interrupts are enabled by setting the appropriate bit in the mie register. The mie register is described in Table 73.

Machine Interrupt Enable Register (mie)			
CSR	0x304		
Bits	Field Name	Attr.	Description
[2:0]	Reserved	WPRI	
3	MSIE	RW	Machine Software Interrupt Enable
[6:4]	Reserved	WPRI	
7	MTIE	RW	Machine Timer Interrupt Enable
[10:8]	Reserved	WPRI	
11	MEIE	RW	Machine External Interrupt Enable
[15:12]	Reserved	WPRI	
16	LIE0	RW	Local Interrupt 0 Enable
17	LIE1	RW	Local Interrupt 1 Enable
18	LIE2	RW	Local Interrupt 2 Enable
...			
31	LIE15	RW	Local Interrupt 15 Enable

**Table 73:** Machine Interrupt Enable Register

### 7.7.4 Machine Interrupt Pending (mip)

The machine interrupt pending (mip) register indicates which interrupts are currently pending. The mip register is described in Table 74.

Machine Interrupt Pending Register (mip)			
CSR	0x344		
Bits	Field Name	Attr.	Description
[2:0]	Reserved	WIRI	
3	MSIP	RO	Machine Software Interrupt Pending
[6:4]	Reserved	WIRI	
7	MTIP	RO	Machine Timer Interrupt Pending
[10:8]	Reserved	WIRI	
11	MEIP	RO	Machine External Interrupt Pending
[15:12]	Reserved	WIRI	
16	LIP0	RO	Local Interrupt 0 Pending
17	LIP1	RO	Local Interrupt 1 Pending
18	LIP2	RO	Local Interrupt 2 Pending
...			
31	LIP15	RO	Local Interrupt 15 Pending

**Table 74:** Machine Interrupt Pending Register

### 7.7.5 Machine Cause (mcause)

When a trap is taken in machine mode, mcause is written with a code indicating the event that caused the trap. When the event that caused the trap is an interrupt, the most-significant bit of mcause is set to 1, and the least-significant bits indicate the interrupt number, using the same encoding as the bit positions in mip. For example, a Machine Timer Interrupt causes mcause to be set to 0x8000\_0007. mcause is also used to indicate the cause of synchronous exceptions, in which case the most-significant bit of mcause is set to 0.

See Table 75 for more details about the mcause register. Refer to Table 76 for a list of synchronous exception codes.

Machine Cause Register (mcause)			
CSR	0x342		
Bits	Field Name	Attr.	Description
[9:0]	EXCCODE	WLRL	A code identifying the last exception.
[30:10]	Reserved	WLRL	
31	Interrupt	WARL	1, if the trap was caused by an interrupt; 0 otherwise.

**Table 75:** Machine Cause Register

Interrupt	Exception Code	Description
1	0–2	Reserved
1	3	Machine software interrupt
1	4–6	Reserved
1	7	Machine timer interrupt
1	8–10	Reserved
1	11	Machine external interrupt
1	12–13	Reserved
1	14	Debug interrupt
1	15	Reserved
1	16	Local Interrupt 0
1	17	Local Interrupt 1
1	18–30	...
1	31	Local Interrupt 15
1	≥32	Reserved
0	0	Instruction address misaligned
0	1	Instruction access fault
0	2	Illegal instruction
0	3	Breakpoint
0	4	Load address misaligned
0	5	Load access fault
0	6	Store/AMO address misaligned
0	7	Store/AMO access fault
0	8	Environment call from U-mode
0	9–10	Reserved
0	11	Environment call from M-mode
0	12–13	Reserved
0	14	Debug
0	≥15	Reserved

**Table 76:** mcause Exception Codes

Note that there are scenarios where a misaligned load or store will generate an access exception instead of an address-misaligned exception. The access exception is raised when the misaligned access should not be emulated in a trap handler, e.g., emulating an access in an I/O region, as such emulation could cause undesirable side-effects.

### 7.7.6 Minimum Interrupt Configuration

The minimum configuration needed to configure an interrupt is shown below.

- Write `mtvec` to configure the interrupt mode and the base address for the interrupt vector table.
- Enable interrupts in memory mapped PLIC register space. The CLINT does not contain interrupt enable bits.

- Write `mie` CSR to enable the software, timer, and external interrupt enables for each privilege mode.
- Write `mstatus` to enable interrupts globally for each supported privilege mode.

## 7.8 Interrupt Priorities

Local interrupts have higher priority than global interrupts, which arrive through the machine external interrupt. As such, if a local and a global interrupt arrive at a hart on the same cycle, the local interrupt will be taken if it is enabled.

Priorities of local interrupts are determined by the local interrupt ID, with Local Interrupt 15 being highest priority. For example, if both Local Interrupt 15 and Local Interrupt 14 arrive in the same cycle, Local Interrupt 15 will be taken.

Local Interrupt 15 is the highest-priority interrupt in the E34 Core Complex. Given that Local Interrupt 15's exception code is also the greatest, it occupies the last slot in the interrupt vector table. This unique position in the vector table allows for Local Interrupt 15's trap handler to be placed in-line, without the need for a jump instruction as with other interrupts when operating in vectored mode. Hence, Local Interrupt 15 should be used for the most latency-sensitive interrupt in the system for a given hart. Individual priorities of global interrupts are determined by the PLIC, as discussed in Chapter 9.

E34 Core Complex interrupts are prioritized as follows, in decreasing order of priority:

- Local Interrupt 15
- ...
- Local Interrupt 0
- Machine external interrupts
- Machine software interrupts
- Machine timer interrupts

## 7.9 Interrupt Latency

Interrupt latency for the E34 Core Complex is four `external_source_for_core_N_clock` cycles, as counted by the number of cycles it takes from signaling of the interrupt to the hart to the first instruction fetch of the handler.

Global interrupts routed through the PLIC incur additional latency of three clock cycles, where the PLIC is clocked by `clock`. This means that the total latency, in cycles, for a global interrupt is:  $4 + 3 \times (\text{external\_source\_for\_core\_N\_clock Hz} \div \text{clock Hz})$ . This is a best case cycle count and assumes the handler is cached or located in ITIM. It does not take into account additional latency from a peripheral source.



## 7.10 Non-Maskable Interrupt

The `rnmi` (resumable non-maskable interrupt) interrupt signal is a level-sensitive input to the hart. Non-maskable interrupts have higher priority than any other interrupt or exception on the hart and cannot be disabled by software. Specifically, they are not disabled by clearing the `mstatus.mie` register.

### 7.10.1 Handler Addresses

The NMI has an associated exception trap handler address. This address is set by external input signals, described in the E34 Core Complex User Guide.

### 7.10.2 RNMI CSRs

These M-mode CSRs enable a resumable non-maskable interrupt (RNMI).

Number	Name	Description
0x350	<code>mnscratch</code>	Resumable Non-maskable scratch register
0x351	<code>mnepc</code>	Resumable Non-maskable EPC value
0x352	<code>mncause</code>	Resumable Non-maskable cause value
0x353	<code>mnstatus</code>	Resumable Non-maskable status

**Table 77:** RNMI CSRs

- The `mnscratch` CSR holds a 32-bit read-write register which enables the NMI trap handler to save and restore the context that was interrupted.
- The `mnepc` CSR is a 32-bit read-write register which on entry to the NMI trap handler holds the PC of the instruction that took the interrupt. The lowest bit of `mnepc` is hardwired to zero.
- The `mncause` CSR holds the reason for the NMI, with bit 31 set to 1, and the NMI cause encoded in the least-significant bits or zero if NMI causes are not supported. The lower bits of `mncause`, defined as the `exception_code`, are as follows:

<code>mncause</code>	NMI Cause	Function
1	Reserved	Reserved
2	<code>rnmi</code> input pin	External <code>rnmi_N</code> input
3	Reserved	Reserved

**Table 78:** `mncause.exception_code` Fields

- The `mnstatus` CSR holds a two-bit field which on entry to the trap handler holds the privilege mode of the interrupted context encoded in the same manner as `mstatus.mpp`.

### 7.10.3 MNRET Instruction

This M-mode only instruction uses the values in `mnepc` and `mnstatus` to return to the program counter and privileged mode of the interrupted context respectively. This instruction also sets the internal `rnmie` state bits.

Encoding is same as MRET except with bit 30 set (i.e., `funct7=0111000`).

### 7.10.4 RNMI Operation

When an RNMI interrupt is detected, the interrupted PC is written to the `mnepc` CSR, the type of RNMI to the `mncause` CSR, and the privilege mode of the interrupted context to the `mnstatus` CSR. An internal microarchitectural state bit `rnmie` is cleared to indicate that processor is in an RNMI handler and cannot take a new RNMI interrupt. The internal `rnmie` bit when clear also disables all other interrupts.

#### Note

These interrupts are called non-maskable because software cannot mask the interrupts, but for correct operation other instances of the same interrupt must be held off until the handler is completed, hence the internal state bit.

The RNMI handler can resume original execution using the new MNRET instruction (described in Section 7.10.3), which restores the PC from `mnepc`, the privilege mode from `mnstatus`, and also sets the internal `rnmie` state bit, which reenables other interrupts.

If the hart encounters an exception while the `rnmie` bit is clear, the exception state is written to `mepc` and `mcause`, `mstatus.mpp` is set to M-mode, and the hart jumps to the RNMI exception handler address.

#### Note

Traps in the RNMI handler can only be resumed if they occur while the handler was servicing an interrupt that occurred outside of machine-mode.

## Chapter 8

# Core-Local Interruptor (CLINT)

This chapter describes the operation of the Core-Local Interruptor (CLINT). The E34 Core Complex CLINT complies with *The RISC-V Instruction Set Manual, Volume II: Privileged Architecture, Version 1.10*.

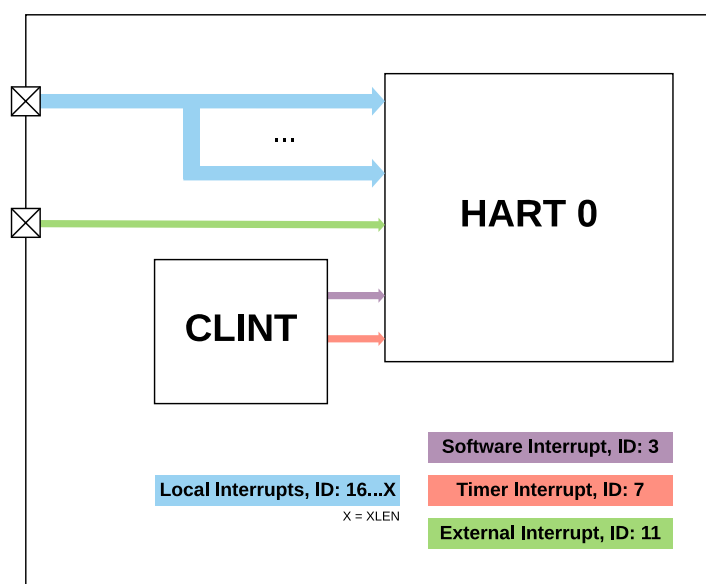

**Figure 75:** CLINT Block Diagram

The CLINT has a small footprint and provides software, timer, and external interrupts directly to the hart.

In addition, there are 16 local external interrupts that can be used for peripherals that require low-latency handling. The CLINT block also holds memory-mapped control and status registers associated with software and timer interrupts.

### 8.1 CLINT Priorities and Preemption

The CLINT has a fixed priority scheme based on interrupt ID, and nested interrupts (preemption) within a given privilege level is not supported. Higher privilege levels may preempt lower

privilege levels, however. The CLINT offers two modes of operation, Direct mode and Vectored mode.

In Direct mode, all interrupts and exceptions trap to `mtvec.BASE`. In Vectored mode, exceptions trap to `mtvec.BASE`, but interrupts will jump directly to their vector table index. See Section 7.7.2 for more information about `mtvec.BASE`.

## 8.2 CLINT Vector Table

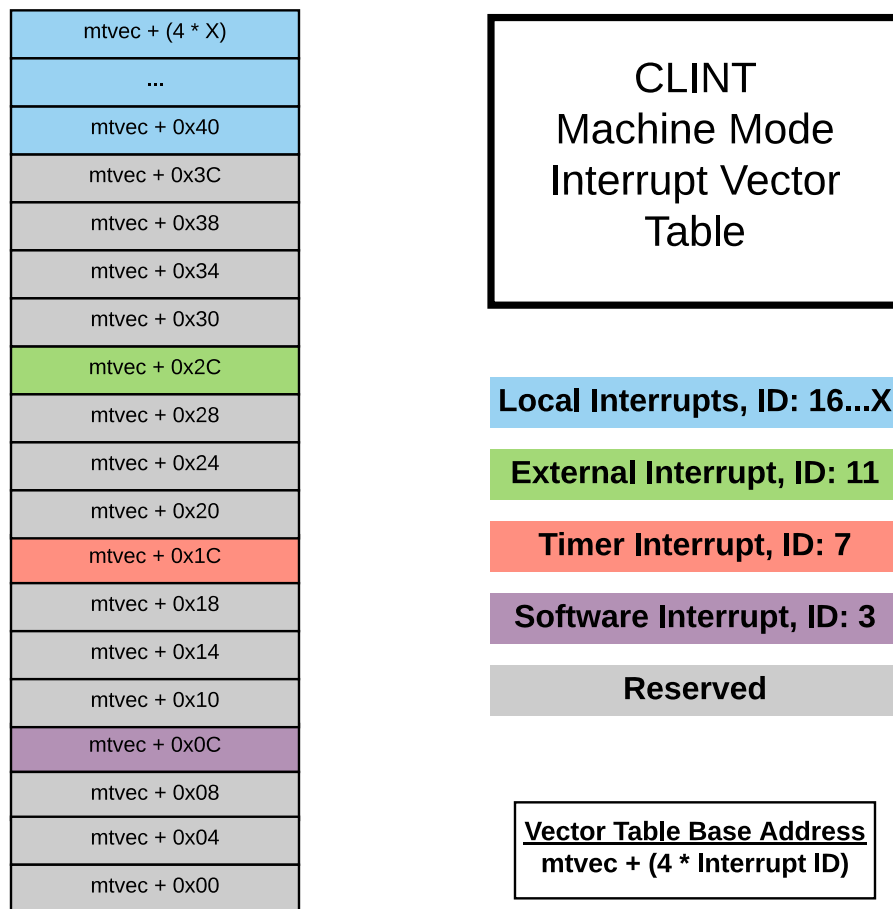

**Figure 76:** CLINT Interrupts and Vector Table

The CLINT vector table is populated with jump instructions, since hardware jumps to the index in the vector table first, then subsequently jumps to the handler. All exception types trap to the first entry in the table, which is `mtvec.BASE`.

An example CLINT vector table is shown below.

```
.weak default_exception_handler
.balign 4, 0
.global default_exception_handler

.weak software_handler
.balign 4, 0
.global software_handler

.weak timer_handler
.balign 4, 0
.global timer_handler

.weak external_handler
.balign 4, 0
.global external_handler

.option norvc
.weak __mtvec_clint_vector_table
#if __riscv_xlen == 32
.balign 128, 0
#else
.balign 256, 0
#endif
.global __mtvec_clint_vector_table
__mtvec_clint_vector_table:

IRQ_0:
    j default_exception_handler
IRQ_1:
    j default_vector_handler
IRQ_2:
    j default_vector_handler
IRQ_3:
    j software_handler
IRQ_4:
    j default_vector_handler
IRQ_5:
    j default_vector_handler
IRQ_6:
    j default_vector_handler
IRQ_7:
    j timer_handler
IRQ_8:
    j default_vector_handler
IRQ_9:
    j default_vector_handler
IRQ_10:
    j default_vector_handler
IRQ_11:
    j external_handler
IRQ_12:
    j default_vector_handler
IRQ_13:
    j default_vector_handler
IRQ_14:
    j default_vector_handler
IRQ_15:
    j default_vector_handler
```

**Figure 77:** CLINT Vector Table Example

## 8.3 CLINT Interrupt Sources

The E34 Core Complex has 16 interrupt sources that can be connected to peripheral devices, in addition to the standard RISC-V software, timer, and external interrupts. These interrupt inputs are exposed at the top-level via the `local_interrupts` signals. Any unused `local_interrupts` inputs should be tied to logic 0. These signals are positive-level triggered.

See the E34 Core Complex User Manual for a description of this interrupt signal.

CLINT Interrupt IDs are provided in Table 79.

E34 Core Complex Interrupt IDs		
ID	Interrupt	Notes
0–2	Reserved	
3	msip	Machine Software Interrupt
4–6	Reserved	
7	mtip	Machine Timer Interrupt
8–10	Reserved	
11	meip	Machine External Interrupt
12–15	Reserved	
16	lint0	Local Interrupt 0
17	lint1	Local Interrupt 1
...	lintX	Local Interrupt X
31	lint15	Local Interrupt 15

**Table 79:** E34 Core Complex Interrupt IDs

## 8.4 CLINT Interrupt Attribute

To help with efficiency of save and restore context, interrupt attributes can be applied to functions used for interrupt handling.

```
void __attribute__((interrupt))
software_handler (void) {
    // handler code
}
```

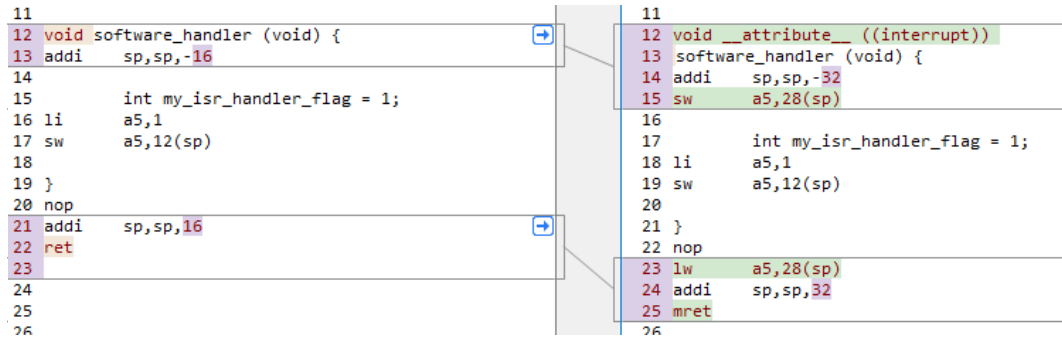

**Figure 78:** CLINT Interrupt Attribute Example

This attribute will save and restore registers that are used within the handler, and insert an `mret` instruction at the end of the handler.

## 8.5 CLINT Memory Map

Table 80 shows the memory map for CLINT on the E34 Core Complex. Note that there are no enable bits for specific interrupts within the CLINT memory map, as the enables for these interrupts reside in the `mie` CSR for each interrupt, and the `mstatus.mie` CSR bit, which enables all machine interrupts globally. See Section 7.7.3 for a description of the interrupt enable bits in the `mie` CSR, and Section 7.7.4 for a description of the interrupt pending bits in the `mip` CSR.

Address	Width	Attr.	Description	Notes
0x0200_0000	4B	RW	msip for hart 0	MSIP Register (1-bit wide)
0x0200_0004			Reserved	
...				
0x0200_3FFF				
0x0200_4000	8B	RW	mtimecmp for hart 0	MTIMECMP Register
0x0200_4008			Reserved	
...				
0x0200_BFF7				
0x0200_BFF8	8B	RW	mtime	Timer Register
0x0200_C000			Reserved	

**Table 80:** CLINT Register Map

## 8.6 Register Descriptions

This section describes the functionality of the memory-mapped registers in the CLINT.

### 8.6.1 MSIP Registers

Machine mode software interrupts are generated by writing to the memory-mapped control register `msip`. The `msip` register is a 32-bit wide **WARL** register, where the upper 31 bits are tied to 0. The least-significant bit is reflected in the MSIP bit of the `mip` CSR. Other bits in the `msip` registers are hardwired to zero. On reset, each `msip` register is cleared to zero.

Software interrupts are most useful for interprocessor communication in multi-hart systems, as harts may write each other's `msip` bits to effect interprocessor interrupts.

### 8.6.2 Timer Registers

`mtime` is a 64-bit read-write register that contains the number of cycles counted from the `rtc_toggle` signal, which is described in the E34 Core Complex User Guide. A timer interrupt is pending whenever `mtime` is greater than or equal to the value in the `mtimecmp` register. The timer interrupt is reflected in the `mtip` bit of the `mip` register, described in Chapter 7.

On reset, `mtime` is cleared to zero. The `mtimecmp` registers are not reset.



## Chapter 9

# Platform-Level Interrupt Controller (PLIC)

This chapter describes the operation of the Platform-Level Interrupt Controller (PLIC) on the E34 Core Complex. The PLIC complies with *The RISC-V Instruction Set Manual, Volume II: Privileged Architecture, Version 1.10* and can support a maximum of 127 external interrupt sources with 7 priority levels.

The E34 Core Complex PLIC resides in the `c1ock` timing domain, allowing for relaxed timing requirements. The latency of global interrupts, as perceived by a hart, increases with the ratio of the `external_source_for_core_N_c1ock` frequency and the `c1ock` frequency.

### 9.1 Memory Map

The memory map for the E34 Core Complex PLIC control registers is shown in Table 81. The PLIC memory map only supports aligned 32-bit memory accesses.

Address	Width	Attr.	Description	Notes
0x0C00_0000			Reserved	
0x0C00_0004	4B	RW	Source 1 priority	See Section 9.3 for more information
...				
0x0C00_01FC	4B	RW	Source 127 priority	
0x0C00_0200			Reserved	
...				
0x0C00_1000	4B	RO	Start of pending array	See Section 9.4 for more information
...				
0x0C00_100C	4B	RO	Last word of pending array	
0x0C00_1010			Reserved	
...				
0x0C00_2000	4B	RW	Start Hart 0 M-Mode interrupt enables	See Section 9.5 for more information
...				
0x0C00_200C	4B	RW	End Hart 0 M-Mode interrupt enables	
0x0C00_2010			Reserved	
...				
0x0C20_0000	4B	RW	Hart 0 M-Mode priority threshold	See Section 9.6 for more information
0x0C20_0004	4B	RW	Hart 0 M-Mode claim/complete	See Section 9.7 for more information
0x0C20_0008			Reserved	
...				
0x0C40_0000			End of PLIC Memory Map	

**Table 81:** PLIC Memory Map

## 9.2 Interrupt Sources

The E34 Core Complex has a total of 127 external global interrupt sources, in addition to the local interrupts described in Table 79.

### Note

In the *RISC-V Platform-Level Interrupt Controller Specification*, interrupt source 0 (ID 0) is unused, so the first usable PLIC Interrupt ID has a value of 1.

Table 82 describes the mapping of external global interrupts to its corresponding top-level `global_interrupts` signal bit. This signal is positive-level triggered and not configurable. See the E34 Core Complex User Guide for further description of `global_interrupts`.

global_interrupts Signal	PLIC Interrupt ID	PLIC Pending / Enable Register
global_interrupts[0]	1	pending1[1] / enable1[1]*
global_interrupts[1]	2	pending1[2] / enable1[2]
global_interrupts[2]	3	pending1[3] / enable1[3]
...		
global_interrupts[126]	127	pending4[31] / enable4[31]
*pending1[0] and enable1[0] are unused		

**Table 82:** Mapping of global\_interrupts Signal Bits to PLIC Interrupt ID

### 9.3 Interrupt Priorities

Each PLIC interrupt source can be assigned a priority by writing to its 32-bit memory-mapped priority register. The E34 Core Complex supports 7 levels of priority. A priority value of 0 is reserved to mean "never interrupt" and effectively disables the interrupt. Priority 1 is the lowest active priority, and priority 7 is the highest. Ties between global interrupts of the same priority are broken by the Interrupt ID; interrupts with the lowest ID have the highest effective priority. See Table 83 for the detailed register description.

PLIC Interrupt Priority Register (priority)				
Base Address		0x0C00_0000 + 4 × Interrupt ID		
Bits	Field Name	Attr.	Rst.	Description
[2:0]	Priority	RW	X	Global interrupt priority
[31:3]	Reserved	RO	0x0	

**Table 83:** PLIC Interrupt Priority Register

### 9.4 Interrupt Pending Bits

The current status of the interrupt source pending bits in the PLIC core can be read from the pending array, organized as 4 words of 32 bits. The pending bit for interrupt ID  $N$  is stored in bit  $(N \bmod 32)$  of word  $(N/32)$ . As such, the E34 Core Complex has 4 interrupt pending registers. Bit 0 of word 0, which represents the non-existent interrupt source 0, is hardwired to zero.

A pending bit in the PLIC core can be cleared by setting the associated enable bit then performing a claim as described in Section 9.7.

PLIC Interrupt Pending Register 1 (pending1)				
Base Address		0x0C00_1000		
Bits	Field Name	Attr.	Rst.	Description
0	Interrupt 0 Pending	RO	0x0	Non-existent global interrupt 0 is hardwired to zero
1	Interrupt 1 Pending	RO	0x0	Pending bit for global interrupt 1
2	Interrupt 2 Pending	RO	0x0	Pending bit for global interrupt 2
...				
31	Interrupt 31 Pending	RO	0x0	Pending bit for global interrupt 31

**Table 84:** PLIC Interrupt Pending Register 1

PLIC Interrupt Pending Register 4 (pending4)				
Base Address		0x0C00_100C		
Bits	Field Name	Attr.	Rst.	Description
0	Interrupt 96 Pending	RO	0x0	Pending bit for global interrupt 96
...				
31	Interrupt 127 Pending	RO	0x0	Pending bit for global interrupt 127

**Table 85:** PLIC Interrupt Pending Register 4

## 9.5 Interrupt Enables

Each global interrupt can be enabled by setting the corresponding bit in the enable registers. The enable registers are accessed as a contiguous array of  $4 \times 32$ -bit words, packed the same way as the pending bits. Bit 0 of enable word 0 represents the non-existent interrupt ID 0 and is hardwired to 0.

Only 32-bit word accesses are supported by the enables array in SiFive RV32 systems.

PLIC Interrupt Enable Register 1 for Hart 0 M-Mode (enable1)				
Base Address		0x0C00_2000		
Bits	Field Name	Attr.	Rst.	Description
0	Interrupt 0 Enable	RO	0x0	Non-existent global interrupt 0 is hard-wired to zero
1	Interrupt 1 Enable	RW	X	Enable bit for global interrupt 1
2	Interrupt 2 Enable	RW	X	Enable bit for global interrupt 2
...				
31	Interrupt 31 Enable	RW	X	Enable bit for global interrupt 31

**Table 86:** PLIC Interrupt Enable Register 1 for Hart 0 M-Mode

PLIC Interrupt Enable Register 4 for Hart 0 M-Mode (enable4)				
Base Address		0x0C00_200C		
Bits	Field Name	Attr.	Rst.	Description
0	Interrupt 96 Enable	RW	X	Enable bit for global interrupt 96
...				
31	Interrupt 127 Enable	RW	X	Enable bit for global interrupt 127

**Table 87:** PLIC Interrupt Enable Register 4 for Hart 0 M-Mode

## 9.6 Priority Thresholds

The E34 Core Complex supports setting of an interrupt priority threshold via the threshold register. The threshold is a **WARL** field, where the E34 Core Complex supports a maximum threshold of 7.

The E34 Core Complex masks all PLIC interrupts of a priority less than or equal to threshold. For example, a threshold value of zero permits all interrupts with non-zero priority, whereas a value of 7 masks all interrupts. If the threshold register contains a value of 5, all PLIC interrupt configured with priorities from 1 through 5 will not be allowed to propagate to the CPU.

PLIC Interrupt Priority Threshold Register (threshold)				
Base Address		0x0C20_0000		
Bits	Field Name	Attr.	Rst.	Description
[2:0]	Threshold	RW	X	Sets the priority threshold
[31:3]	Reserved	RO	0x0	

**Table 88:** PLIC Interrupt Priority Threshold Register

## 9.7 Interrupt Claim Process

A E34 Core Complex hart can perform an interrupt claim by reading the `claim_complete` register (Table 89), which returns the ID of the highest-priority pending interrupt or zero if there is no pending interrupt. A successful claim also atomically clears the corresponding pending bit on the interrupt source.

A E34 Core Complex hart can perform a claim at any time, even if the MEIP bit in its `mip` (Table 74) register is not set.

The claim operation is not affected by the setting of the priority threshold register.

## 9.8 Interrupt Completion

A E34 Core Complex hart signals it has completed executing an interrupt handler by writing the interrupt ID it received from the claim to the `claim_complete` register (Table 89). The PLIC does not check whether the completion ID is the same as the last claim ID for that target. If the completion ID does not match an interrupt source that is currently enabled for the target, the completion is silently ignored.

PLIC Claim/Complete Register for Hart 0 M-Mode ( <code>claim_complete</code> )				
Base Address		0x0C20_0004		
Bits	Field Name	Attr.	Rst.	Description
[31:0]	Interrupt Claim/Complete for Hart 0 M-Mode	RW	X	A read of zero indicates that no interrupts are pending. A non-zero read contains the id of the highest pending interrupt. A write to this register signals completion of the interrupt ID written.

**Table 89:** PLIC Claim/Complete Register for Hart 0 M-Mode

The PLIC cannot forward a new interrupt to a hart that has claimed an interrupt, but has not yet finished the complete step of the interrupt handler. Thus, the PLIC does not support preemption of global interrupts to an individual hart.

Interrupt IDs for global interrupts routed through the PLIC are independent of the interrupt IDs for local interrupts. The PLIC handler may check for additional pending global interrupts once the initial claim/complete process has finished, prior to exiting the handler. This method could save additional PLIC save/restore context for global interrupts.

## 9.9 Example PLIC Interrupt Handler

Since the PLIC interfaces with the CPU through external interrupt #11, the external handler must contain an additional claim/complete step that is used to handshake with the PLIC logic.

```
void external_handler() {
```

```
//get the highest priority pending PLIC interrupt
uint32_t int_num = plic.claim_complete;

//branch to handler
plic_handler[int_num]();

//complete interrupt by writing interrupt number back to PLIC
plic.claim_complete = int_num;

// Add additional checks for PLIC pending here, if desired
}
```

If a CPU reads `claim_complete` and it returns 0, the interrupt does not require processing, and thus write-back of the `claim/complete` is not necessary.

The `plic_handler[]()` routine shown above demonstrates one method to implement a software table where the offset of the function that resides within the table is determined by the PLIC interrupt ID. The PLIC interrupt ID is unique to the PLIC, in that it is completely independent of the interrupt IDs of local interrupts.

## Chapter 10

# TileLink Error Device

The Error Device is a TileLink slave that responds to all requests with a TileLink denied error and all reads with a corrupt error. It has no registers. The entire memory range discards writes and returns zeros on read. Both operation acknowledgements carry an error indication.

The Error Device serves a dual role. Internally, it is used as a landing pad for illegal off-chip requests. However, it is also useful for testing software handling of bus errors.



## Chapter 11

# Power Management

The following chapter describes power modes and establishes flows for powering up, powering down, and resetting the hardware of the E34 Core Complex.

### 11.1 Power Modes

Power modes include normal run mode and wait-for-interrupt clock gating mode using the WFI instruction. Additionally, there is a full power down mode supported via the CEASE instruction. These modes are covered in detail below.

### 11.2 Run Mode

The hart is fully operational in run mode, and SiFive designs include the option to include coarse-grained architectural clock gating. When this feature is enabled in the hart, the I-Cache, D-Cache, integer pipeline, Debug Logic, and Floating Point Unit (FPU) each contain their own clock gate module. The clock gating feature will enable automatic clock gating of functional units when they are inactive, and allow the hart to gate its own clock(s) based on activity. To further reduce power while in run mode, users may choose to reduce `external_source_for_core_N_clock`, which is required to be changed synchronously to the rest of the clocks in the system. It is important to note that the clock relationships with the rest of the system must still be maintained if `external_source_for_core_N_clock` is reduced.

### 11.3 WFI Clock Gate Mode

WFI clock gating mode can be entered by executing the WFI instruction. The assembly-level instruction is simply `wfi`, and executing the C-code method using the GCC compiler can be accomplished with `asm("WFI")`.

#### 11.3.1 WFI Wake Up

Wake up from a WFI occurs when the hart receives any interrupt. Depending on the software configuration, the hart will either immediately enter the interrupt handler, or resume execution on the instruction immediately after the WFI.

If interrupts are enabled and `mstatus.MIE=1`, then the hart will wake when an interrupt is enabled and becomes pending, and immediately enter the interrupt handler. Upon exit from the interrupt handler, program execution will resume at the instruction following the `WFI`.

If interrupts are enabled but `mstatus.MIE=0`, then the hart will wake when an interrupt is enabled and becomes pending, but will not enter the interrupt handler. It will simply resume at the instruction immediately after the `WFI` in this case.

To prevent an interrupt source from waking a hart, the enable bit for that interrupt must be written to 0 prior to executing the `WFI` instruction. If any interrupts are pending upon executing a `WFI` instruction, then the `WFI` is effectively treated as a `NOP` instruction.

Refer to Chapter 7 for more detail on interrupt configuration.

## 11.4 CEASE Instruction for Power Down

To fully power down, follow the steps described in Section 11.9, where the last step is to execute a `CEASE` instruction. Once the `CEASE` instruction is executed, the core will not retire another instruction until reset. The `CEASE` opcode is `0x30500073` and can be implemented in either assembly or C code. To create an assembly-level function using GCC, consider the following example.

```
.global _cease
.type      _cease, @function
_ceil:
    .word 0x30500073
    ret
```

The next example demonstrates how to implement the `CEASE` instruction within a function in C code.

```
static inline void cease()
{
    __asm__ __volatile__ (".word 0x30500073" : : : "memory"); // CEASE
}
```

## 11.5 Hardware Reset

The following list summarizes the hardware reset values required by the RISC-V Privileged Specification and applies to all SiFive designs.

1. Privilege mode is set to machine mode.
2. `mstatus.MIE` and `mstatus.MPRV` are required to be 0.
3. The `misa` register holds the full set of supported extensions for that implementation, and `misa.MXL` defaults to the widest supported ISA available, referred to as `MXLEN`.
4. The `pc` is set to the implementation specific reset vector.

5. The `mcause` register is set to 0x0 at reset.
6. The PMP configuration fields for address matching mode (A) and Lock (L) are set to 0, which defaults to no protection for any privilege level.

The internal state of the rest of the system should be completed by software early in the boot flow.

## 11.6 Early Boot Flow

For the early stages of boot, some of the first things software must consider are listed below:

- The global pointer (`gp` or `x3`) user register should be initialized to the `__global_pointer$` linker generated symbol and not changed at any point in the application program.
- The stack pointer (`sp` or `x2`) user register should be also set up as a standard part of the boot flow.
- All other user registers (`x1`, `x4` - `x31`) can be written to 0 upon initial power-on.
- The `mtvec` register holds the default exception handler base address, so it is important to set up this register early in the boot flow so it points to a properly aligned, valid exception handler location.
- Zero out the `bss` section, and copy data sections into RAM areas as needed.

## 11.7 Interrupt State During Early Boot

Since `mstatus.MIE` defaults to 0, all interrupts are disabled globally out of reset. Prior to enabling interrupts globally through `mstatus.MIE`, consider the following:

- Ensure no timer interrupts are pending by checking the `mip.MTIP` bit. The `mtime` register is 0 out of reset, and starts running immediately. However, the `mtimecmp` register does not have a reset value.

If no timer interrupt is required, leave `mie.MTIE` equal to 0 prior to enabling global interrupt with `mstatus.MIE`.

If the application requires a timer interrupt, write `mtimecmp` to a value in the future for the next timer interrupt before enabling `mstatus.MIE`.

- Write the remaining bits in the `mie` CSR to the desired value to enable interrupts based on the requirements of the system. This register is not defined to have a reset value.
- Each `msip` register in the Core-Local Interruptor (CLINT) or Core-Local Interrupt Controller (CLIC) address space is reset to 0, so no specific initialization is required for local software interrupts.

Since `msip` is memory-mapped, any hart in the system may trigger a software interrupt on another hart, so this should be considered during the boot flow on a multi-hart system.

- If a Platform-Level Interrupt Controller (PLIC) exists, check the PLIC pending status. The PLIC memory mapped pending bits are read-only, so the pending status should be cleared at the source if they reset to a non-zero status. Then, enable the PLIC interrupts as required by the system prior to enabling interrupts in the system via `mstatus.MIE`.

## 11.8 Other Boot Time Considerations

- Write 0 to enable the appropriate bits in the Feature Disable CSR as described in Table 66.
- Ensure the remaining bits in the `mstatus` CSR are written to the desired application specific configuration at boot time.
- If a design includes user and supervisor privilege levels, initialize `medeleg` and `mideleg` registers to 0 until supervisor-level trap handling is set up correctly using `stvec`.
- The `mcause`, `mepc`, and `mtval` registers hold important information in the event of a synchronous exception. If the synchronous exception handler forces reset in the application, the contents of these registers can be checked to understand root cause.
- The PMP address and configuration CSRs are required to be initialized if user or supervisor privilege levels are part of the design. By default, user and supervisor modes have no permissions to the memory map unless explicitly granted by the PMP.
- The `mcycle` CSR is a 64-bit counter on both RV32 and RV64 systems, and it counts the number of cycles executed by the hart. It has an arbitrary value after reset and can be written as needed by the application.
- Instructions retired can be counted by the `minstret` register, and this also has an arbitrary value after reset. This can be written to any given value.
- The `mhpmeventx` CSR selects which hardware events to count, where the count is reflected in `mhpmcounterx`. At any point, the `mhpmcounterx` registers can be directly written to reset their value when the `mhpmeventx` register has the proper event selected.
- There is no requirement for boot time initialization to any of the registers within the Debug Module, unless there is an application specific reason to do so.
- All other CSRs during boot time initialization should be considered based on system and application requirements.

## 11.9 Power-Down Flow

Designate one core as primary and all others as secondary. For our Core IP product, coordination with an External Agent is required.

1. External Agent: Wait for communication from primary core to initiate the following steps:
  - a. Stop sending inbound traffic (both transactions and interrupts) into the core complex.

- b. Wait until all outstanding requests to the Core Complex are completed, then
  - c. Wait until `cease_from_tile_x` is high for the primary core and all secondary cores.
  - d. Once `cease_from_tile_x` is high for primary core and all secondary cores, apply reset to the whole core complex.
2. Primary core:
- a. The following sequence should be executed in machine mode and NOT out of a remote ITIM/DTIM.
  - b. Communicate with external agent to initiate cease power-down sequence.
  - c. Poll external agent until steps 1.a and 1.b are completed.
  - d. Disable all interrupts except those related to bus errors/memory corruption, and IPIs (if using enabled IPI to coordinate power-down sequence among cores).
    - i. Copy contents of any TIMs/LIMs into external memory.
    - ii. Primary core: if there is an L2 cache, flush it (all addresses at which cacheable physical memory exists).
    - iii. If there is no L2 cache, but there is a data cache, flush it using full-cache variant of `CFLUSH.D.L1`, if available; or per-line variant if not
  - e. Disable all interrupts.
  - f. Execute CEASE instruction.

## Chapter 12

# Debug

This chapter describes the operation of SiFive debug hardware, which follows *The RISC-V Debug Specification, Version 0.13*. Currently only interactive debug and hardware breakpoints are supported.

### 12.1 Debug Module

The Debug Module (DM) handles nearly all the functions related to debugging. It is a slave to both the Debug Module Interface (DMI) coming from the probe and a TileLink bus coming from the core(s). From the perspective of the core, the DM appears as a 4K block in the memory map. The DM memory map as seen from the perspective of the core is shown in Table 91 and the register map from the perspective of the DMI is shown in Table 90.

Most of the DM is clocked by the TileLink (system) clock. The `dmcontrol` register is accessible when the system clock is not running, mainly to be able to write to `haltreq` while the core is in reset due to `ndreset`. Doing so generates a debug interrupt and will interrupt the selected core immediately once it is out of reset or interrupt it during a WFI instruction.

DMI Address	Name	Description
0x11	dmstatus	Debug Module Status. See Table 102 for more information.
0x10	dmcontrol	Debug Module Control. See Table 103 for more information.
0x12	hartinfo	Hart Information. See Table 104 for more information.
0x14	hawindowse1	Read/Write. Select which window of up to 32 harts is visible in hawindow. <b>Not used by SiFive</b> since all SiFive systems have less than 32 harts.
0x40	haltsum0	Read-only. Halt Summary 0: Bit n reads 1 if hart n is halted.
0x13	haltsum1	Read-only. Only present on systems with >32 harts, so <b>not used by SiFive</b> .
0x16	abstractcs	Abstract Control and Status. See Table 105 for more information.
0x18	abstractauto	Select whether access to particular DATA or PROGBUF locations will re-execute the last command. Used for block transfers or other repeating commands. See Table 107 for more information.
0x17	command	Initiate abstract command. See Table 106 for more information.
0x04-0x0F	data0 - data11	Read/Write DATA registers. 32-bit SiFive cores have 1 data register, 64-bit cores have 2.
0x20-0x2F	progbuf0 - progbuf15	Read/Write PROGBUF registers.
0x32	dmcs2	Fields to set up and read back Halt Group or Resume Group configuration. Present by default on systems with more than 1 hart or with any external triggers. See Table 108 for more information.
0x37-0x3F	sbXXXX	Read/Write. System Bus Access.

**Table 90:** Debug Module Register Map Seen from the Debug Module Interface

From the point of view of the core, the DM appears as a 4K block of memory. It is mapped into low memory so that memory references can use addresses relative to the \$zero register.

#### Note

Logic in the core prevents non-debug-mode code from accessing the debug region. However, this logic does not intercept accesses from the Front Port. This means that it is possible for Front Port accesses to interfere with a debug session by writing to various offsets within the debug region. If this occurs, the user may need to restart the debugger or reset the core to continue a debug session. To work around this, do not access the debug module memory region via the Front Port.

TL Address	Name	Attr.	Description
0x100	HALTED	WO	Written with hartid by ROM code when hart gets a debug interrupt or reenters ROM due to EBREAK. Sets halted[hartid]. If an abstract command was running, writing this also clears busy.
0x104	GOING	WO	Written by ROM code when it begins executing a command started by FLAGS[hartid].go. Clears FLAGS[hartid].go.
0x108	RESUMING	WO	Written with hartid by hart when it is about to resume. Sets resumeack[hartid] and clears halted[hartid] and FLAGS[hartid].resume.
0x10C	EXCEPTION	WO	Written by hart when it encounters an exception in debug mode. Sets cmderr to "exception".
0x300	WHERETO	RO	JAL to ABSTRACT. This opcode is constructed by DM hardware and is needed because ABSTRACT is not a fixed address (depends on number of PROGBUF words selected in the configuration).
contiguous	ABSTRACT	RO	2 words constructed by DM hardware based on abstract command written from DTM.  +0: If transfer set, construct instruction to load/store specific register to/from DATA[0] (32 bits) or DATA[1:0] (64 bits), else NOP.  +4: If postexec set, then NOP to fall thru and execute PROGBUF, else EBREAK to return to ROM park loop.
contiguous	PROGBUF	RW	Configurable number (typically 16, max 16) of R/W words to be filled in by debugger and executed by hart.
contiguous	IMPEBREAK	RO	Optional - If present, reads as EBREAK to return to ROM park loop when execution runs off the end of PROGBUF.  In E2, default is 2-word PROGBUF and IMPEBREAK present. Most others have 16-word PROGBUF and no IMPEBREAK.
0x380-0x3BF	DATA	RW	Configurable number (1 for 32-bit or 2 for 64-bit, max 12) of R/W words intended for use for data transfer between debugger and hart. Since it is contiguous with PROGBUF, the debugger may use DATA as an extension of PROGBUF.
0x400-0x7FF	FLAGS	RO	One byte flag per hart.  Bit 0 (go): Set by writing an abstract command, cleared by ROM write to GOING. ROM will jump to WHERETO.

**Table 91:** Debug Module Memory Map from the Perspective of the Core



TL Address	Name	Attr.	Description
			Bit 1 (resume): Set by writing 1 to resumereq[hartid]. Cleared by ROM write of hartid to RESUMING. ROM restores s0 then executes dret.
0x800-0xFFF	ROM	RO	<p>Debug interrupt or EBREAK enters at 0x800, saves s0, writes hartid to HALTED, then busy-waits for <code>FLAGS[hartid] &gt; 0</code>.</p> <p>If <code>FLAGS[hartid].go</code>, write 0 to GOING, then jump to WHERETO.</p> <p>Else write hartid to RESUMING, then execute dret to return to user program.</p> <p>ROM Source Code: <a href="https://github.com/chipsalliance/rocket-chip/blob/master/scripts/debug_rom/debug_rom.S">https://github.com/chipsalliance/rocket-chip/blob/master/scripts/debug_rom/debug_rom.S</a></p>

**Table 91:** Debug Module Memory Map from the Perspective of the Core

## 12.2 Trace and Debug Registers

This section describes the per hart Trace and Debug Registers (TDRs), which are mapped into the CSR space as follows:

CSR	Name	Allowed Access Mode	Description
0x7B0	dcsr	Debug	Debug Control and Status. See Table 93 for more information.
0x7B1	dpc	Debug	Debug PC. Stores execution address just before debug exception and to return to at dret.
0x7B2	dscratch0	Debug	Debug Scratch Register 0.
0x7A0	tselect	Debug, Machine	Trigger Registers. Most configs implement 2, 4, or 8 triggers. <ul style="list-style-type: none"> <li>• tselect (0x7A0) selects a trigger. tdata1 is mcontrol, tdata2 is the address for comparison.</li> <li>• Triggers are all type 2 (address/data).</li> <li>• select is fixed at 0 meaning all triggers compare addresses only (no data value).</li> <li>• Load, store, execute, U-mode, S-mode, and M-mode filters all supported.</li> <li>• timing is fixed at 0 meaning breaks happen just before the event.</li> <li>• size is fixed at 0 meaning accesses of any size that cover any part of the trigger address range will fire.</li> <li>• match values:               <ul style="list-style-type: none"> <li>◦ 0x0 - Single address</li> <li>◦ 0x1 - Power-of-2 range, limited to 64 bytes in SiFive implementations.</li> <li>◦ 0x2 - ≥ address</li> <li>◦ 0x3 - &lt; address</li> <li>◦ Others not supported by SiFive.</li> </ul> </li> <li>• chain is supported. When set, this trigger and the next must match at the same time to fire. Typically used for a range breakpoint using 2 triggers, one with match=0x2 and one with match=0x3. This is not a sequential trigger.</li> </ul>
0x7A1	tdata1	Debug, Machine	
0x7A2	tdata2	Debug, Machine	
0x7A3	tdata3	Debug, Machine	

**Table 92:** Debug Control and Status Registers

The dcsr, dpc, and dscratch registers are only accessible in debug mode, while the tselect and tdata1-3 registers are accessible from either debug mode or machine mode.

### 12.2.1 Debug Control and Status Register (dcsr)

This register gives information about debug capabilities and status. Its detailed functionality is described in *The RISC-V Debug Specification, Version 0.13*.

Debug Control and Status Register (dcsr)			
CSR	0x7B0		
Bits	Field Name	Attr.	Description
[1:0]	prv	RW	Privilege level of processor prior to debug exception and to return to at dret.
2	step	RW	Set to 0x1 to single-step.
3	nmip	RO	Non-maskable interrupt pending. Not used by SiFive.
4	mprven	WARL	Not used by SiFive.
[7:5]	cause	RO	Indicates cause of most recent debug exception.
8	stoptime	WARL	0x1 will stop timers in debug mode. Not used by SiFive (timers continue).
9	stopcount	WARL	0x1 will stop counters in debug mode. Not used by SiFive (counters continue).
10	stepie	WARL	Enable interrupts when stepping. Not used by SiFive (interrupts disabled).
11	ebreaku	RW	EBREAK instructions in U-mode enter debug mode (vs. breakpoint exception).
12	ebreaks	RW	EBREAK instructions in S-mode enter debug mode.
13	ebreakm	RW	EBREAK instructions in M-mode enter debug mode.
[27:14]	Reserved		
[31:28]	xdebugver	RO	Version

**Table 93:** Debug Control and Status Register

### 12.2.2 Debug PC (dpc)

When entering debug mode, the current PC is copied here. When leaving debug mode, execution resumes at this PC.

### 12.2.3 Debug Scratch (dscratch)

This register is generally reserved for use by Debug ROM in order to save registers needed by the code in Debug ROM. The debugger may use it as described in *The RISC-V Debug Specification, Version 0.13*.

### 12.2.4 Trace and Debug Select Register (tselect)

To support a large and variable number of TDRs for tracing and breakpoints, they are accessed through one level of indirection where the `tselect` register selects which bank of three `tdata1-3` registers are accessed via the other three addresses.

The `tselect` register has the format shown below:

Trace and Debug Select Register (tselect)			
CSR	0x7A0		
Bits	Field Name	Attr.	Description
[31:0]	index	WARL	Selection index of trace and debug registers

**Table 94:** Trace and Debug Select Register

The `index` field is a **WARL** field that does not hold indices of unimplemented TDRs. Even if `index` can hold a TDR index, it does not guarantee the TDR exists. The `type` field of `tdata1` must be inspected to determine whether the TDR exists.

### 12.2.5 Trace and Debug Data Registers (tdata1-3)

The `tdata1-3` registers are 32-bit read/write registers selected from a larger underlying bank of TDR registers by the `tselect` register.

Trace and Debug Data Register 1 (tdata1)			
CSR	0x7A1		
Bits	Field Name	Attr.	Description
[27:0]	TDR-Specific Data		
[31:28]	type	RO	The type of trace and debug register selected by <code>tselect</code>

**Table 95:** Trace and Debug Data Register 1

Trace and Debug Data Registers 2 and 3 (tdata2/3)			
CSR	0x7A2 - 0x7A3		
Bits	Field Name	Attr.	Description
[31:0]	TDR-Specific Data		

**Table 96:** Trace and Debug Data Registers 2 and 3

The high nibble of `tdata1` contains a 4-bit type code that is used to identify the type of TDR selected by `tselect`. The currently defined types are shown below:

Value	Description
0x0	No such TDR register
0x1	Reserved
0x2	Address/Data Match Trigger
≥0x3	Reserved

**Table 97:** tdata Types

The dmode bit selects between debug mode (dmode=1) and machine mode (dmode=0) views of the registers, where only debug mode code can access the debug mode view of the TDRs. Any attempt to read/write the tdata1-3 registers in machine mode when dmode=1 raises an illegal instruction exception.

## 12.3 Breakpoints

The E34 Core Complex supports four hardware breakpoint registers per hart, which can be flexibly shared between debug mode and machine mode.

When a breakpoint register is selected with tselect, the other CSRs access the following information for the selected breakpoint:

CSR Name	Breakpoint Alias	Description
tselect	tselect	Breakpoint selection index
tdata1	mcontrol	Breakpoint match control
tdata2	maddress	Breakpoint match address
tdata3	N/A	Reserved

**Table 98:** TDR CSRs When Used as Breakpoints

### 12.3.1 Breakpoint Match Control Register (mcontrol)

Each breakpoint control register is a read/write register laid out in Table 99.

Breakpoint Match Control Register (mcontrol)				
CSR	0x7A1			
Bits	Field Name	Attr.	Rst.	Description
0	R	WARL	X	Address match on LOAD
1	W	WARL	X	Address match on STORE
2	X	WARL	X	Address match on Instruction FETCH
3	U	WARL	X	Address match on user mode
4	S	WARL	X	Address match on supervisor mode
5	Reserved	WPRI	X	Reserved
6	M	WARL	X	Address match on machine mode
[10:7]	match	WARL	X	Breakpoint Address Match type
11	chain	WARL	0x0	Chain adjacent conditions.
[15:12]	action	WARL	0x0	Breakpoint action to take.
[17:16]	size0	WARL	0x0	Size of the breakpoint. Always 0.
18	timing	WARL	0x0	Timing of the breakpoint. Always 0.
19	select	WARL	0x0	Perform match on address or data. Always 0.
20	Reserved	WPRI	X	Reserved
[26:21]	maskmax	RO	0x4	Largest supported NAPOT range
27	dmode	RW	0x0	Debug-Only access mode
[31:28]	type	RO	0x2	Address/Data match type, always 0x2

**Table 99:** Breakpoint Match Control Register

The `type` field is a 4-bit read-only field holding the value 0x2 to indicate this is a breakpoint containing address match logic.

The `action` field is a 4-bit read-write **WARL** field that specifies the available actions when the address match is successful. The value 0 generates a breakpoint exception. The value 1 enters debug mode. Other actions are not implemented.

The R/W/X bits are individual **WARL** fields, and if set, indicate an address match should only be successful for loads, stores, and instruction fetches, respectively. All combinations of implemented bits must be supported.

The M/S/U bits are individual **WARL** fields, and if set, indicate that an address match should only be successful in the machine, supervisor, and user modes, respectively. All combinations of implemented bits must be supported.

The `match` field is a 4-bit read-write **WARL** field that encodes the type of address range for breakpoint address matching. Three different match settings are currently supported: exact, NAPOT, and arbitrary range. A single breakpoint register supports both exact address matches and matches with address ranges that are naturally aligned powers-of-two (NAPOT) in size. Breakpoint registers can be paired to specify arbitrary exact ranges, with the lower-numbered breakpoint register giving the byte address at the bottom of the range and the higher-numbered

breakpoint register giving the address 1 byte above the breakpoint range, and using the `chain` bit to indicate both must match for the action to be taken.

NAPOT ranges make use of low-order bits of the associated breakpoint address register to encode the size of the range as follows:

address	Match type and size
a...aaaaaa	Exact 1 byte
a...aaaaa0	2-byte NAPOT range
a...aaaa01	4-byte NAPOT range
a...aaa011	8-byte NAPOT range
a...aa0111	16-byte NAPOT range
a...a01111	32-byte NAPOT range
...	...
a01...1111	$2^{31}$ -byte NAPOT range

**Table 100:** NAPOT Size Encoding

The `maskmax` field is a 6-bit read-only field that specifies the largest supported NAPOT range. The value is the logarithm base 2 of the number of bytes in the largest supported NAPOT range. A value of 0 indicates that only exact address matches are supported (1-byte range). A value of 31 corresponds to the maximum NAPOT range, which is  $2^{31}$  bytes in size. The largest range is encoded in `address` with the 30 least-significant bits set to 1, bit 30 set to 0, and bit 31 holding the only address bit considered in the address comparison.

To provide breakpoints on an exact range, two neighboring breakpoints can be combined with the `chain` bit. The first breakpoint can be set to match on an address using `action` of 2 (greater than or equal). The second breakpoint can be set to match on address using `action` of 3 (less than). Setting the `chain` bit on the first breakpoint prevents the second breakpoint from firing unless they both match.

### 12.3.2 Breakpoint Match Address Register (`address`)

Each breakpoint match address register is a 32-bit read/write register used to hold significant address bits for address matching and also the unary-encoded address masking information for NAPOT ranges.

### 12.3.3 Breakpoint Execution

Breakpoint traps are taken precisely. Implementations that emulate misaligned accesses in software will generate a breakpoint trap when either half of the emulated access falls within the address range. Implementations that support misaligned accesses in hardware must trap if any byte of an access falls within the matching range.

Debug-mode breakpoint traps jump to the debug trap vector without altering machine-mode registers.

Machine-mode breakpoint traps jump to the exception vector with "Breakpoint" set in the `mcause` register and with `badaddr` holding the instruction or data address that caused the trap.

### 12.3.4 Sharing Breakpoints Between Debug and Machine Mode

When debug mode uses a breakpoint register, it is no longer visible to machine mode (that is, the `tdrtype` will be 0). Typically, a debugger will leave the breakpoints alone until it needs them, either because a user explicitly requested one or because the user is debugging code in ROM.

## 12.4 Debug Memory Map

This section describes the debug module's memory map when accessed via the regular system interconnect. The debug module is only accessible to debug code running in debug mode on a hart (or via a debug transport module). The following addresses are offsets from the base address of the Debug Module. Note that the PMP must allow M-mode access to the debug module address range for debugging to be possible.

### 12.4.1 Debug RAM and Program Buffer (0x300–0x3FF)

The E34 Core Complex has 16 32-bit words of program buffer for the debugger to direct a hart to execute arbitrary RISC-V code. Its location in memory can be determined by executing `aiupc` instructions and storing the result into the program buffer.

The E34 Core Complex has one 32-bit words of debug data RAM. Its location can be determined by reading the `DMHARTINFO` register as described in the RISC-V Debug Specification. This RAM space is used to pass data for the Access Register abstract command described in the RISC-V Debug Specification. The E34 Core Complex supports only general-purpose register access when harts are halted. All other commands must be implemented by executing from the debug program buffer.

In the E34 Core Complex, both the program buffer and debug data RAM are general-purpose RAM and are mapped contiguously in the Core Complex memory space. Therefore, additional data can be passed in the program buffer, and additional instructions can be stored in the debug data RAM.

Debuggers must not execute program buffer programs that access any debug module memory except defined program buffer and debug data addresses.

The E34 Core Complex does not implement the `DMSTATUS.anyhavereset` or `DMSTATUS.allhavereset` bits.



### 12.4.2 Debug ROM (0x800–0xFFF)

This ROM region holds the debug routines on SiFive systems. The actual total size may vary between implementations.

### 12.4.3 Debug Flags (0x100–0x110, 0x400–0x7FF)

The flag registers in the debug module are used for the debug module to communicate with each hart. These flags are set and read used by the debug ROM and should not be accessed by any program buffer code. The specific behavior of the flags is not further documented here.

### 12.4.4 Safe Address

In the E34 Core Complex, the debug module contains the debug module address range in the memory map. Memory accesses to these addresses raise access exceptions, unless the hart is in debug mode. This property allows a "safe" location for unprogrammed parts, as the default mtvec location is 0x0.

## 12.5 Debug Module Interface

The SiFive Debug Module (DM) conforms to *The RISC-V Debug Specification, Version 0.13*. A debug probe or agent connects to the Debug Module through the Debug Module Interface (DMI). The following sections describe notable spec options used in the implementation and should be read in conjunction with the RISC-V Debug Specification.

DMI is a simple read/write bus whose master is the DTM (if it exists, otherwise DMI passes through to customer logic) and whose slave is the Debug Module. The master sends a request to the slave and the slave responds with a response. A request is considered sent if req\_ready=1 indicating the master is sending a request and req\_valid=1 indicating the slave is accepting the request on this cycle. Similarly, the response is sent when both resp\_valid=1 indicating the slave is sending a response and resp\_ready=1 indicating the master is accepting it.

#### Note

It is the responsibility of the debugger to simulate virtual address accesses by accessing the page tables directly, then sending the translated physical address to hardware when doing the access.

#### Note

The Debug Module registers are not directly accessible from the core.

Group	Signal	Source	Description
System	clock	system	All signals timed to this clock. With JTAG DTM, this clock is the JTAG TCK.
	reset	system	Synchronous reset. Generated by power-on reset circuit.
Request Bus	req_ready	slave	Slave ready to receive request.
	req_valid	master	Master's request valid.
	req_addr	master	Configurable width address bus. 0x7 for SiFive.
	req_data	master	32-bit write data bus.
	req_op	master	<ul style="list-style-type: none"> <li>• 0x0 = None</li> <li>• 0x1 = Read</li> <li>• 0x2 = Write</li> <li>• 0x3 = Reserved</li> </ul>
Response Bus	resp_ready	master	Master is ready to receive response.
	resp_valid	slave	Slave response is valid.
	resp_data	slave	32-bit read data bus.
	resp_op	slave	<ul style="list-style-type: none"> <li>• 0x0 = Success</li> <li>• 0x1 = Failure</li> <li>• 0x2 = Not used</li> <li>• 0x3 = Reserved</li> </ul>

**Table 101:** Debug Module Interface Signals

### 12.5.1 Debug Module Status Register (dmstatus)

dmstatus holds the DM version number and other implementation information. Most importantly, it contains status bits that indicate the current state of the selected hart(s).

Debug Module Status Register (dmstatus)			
DMI Address		0x11	
Bits	Field Name	Attr.	Description
[3:0]	version	RO	Implementation version number.
4	Reserved		
5	hasresethaltreq	RO	1 if resethaltreq exists.
[7:6]	Reserved		
8	anyhalted	RO	Any currently selected hart is halted.
9	allhalted	RO	All currently selected harts are halted.
10	anyrunning	RO	Any currently selected hart is running.
11	allrunning	RO	All currently selected harts are running.
12	anyunavail	RO	Any currently selected hart is not available (i.e. is powered down). DM supports it, but not currently used by SiFive cores.
13	allunavail	RO	All currently selected harts are not available (i.e. is powered down). DM supports it, but not currently used by SiFive cores.
14	anynonexistent	RO	Any currently selected hart does not exist in the system.
15	allnonexistent	RO	All currently selected harts do not exist in the system.
16	anyresumeack	RO	Any currently selected hart has resumed execution.
17	allresumeack	RO	All currently selected harts have resumed execution.
18	anyhavereset	RO	Any currently selected hart has been reset, but reset has not been acknowledged.
19	allhavereset	RO	All currently selected harts have been reset, but reset has not been acknowledged.
[21:20]	Reserved		
22	impebreak	RO	1 if PROGBUF is followed by implicit EBREAK. Generally 1 for E2 cores, 0 otherwise.
[31:23]	Reserved		

**Table 102:** Debug Module Status Register

### 12.5.2 Debug Module Control Register (dmcontrol)

A debugger performs most hart controls through the dmcontrol register.

Debug Module Control Register (dmcontrol)			
DMI Address		0x10	
Bits	Field Name	Attr.	Description
0	dmactive	RW	0 resets the DM, 1 puts the DM in operational mode. Drives dmactive output that could be used by a system power controller to maintain power to the DM while it is being used. When 1, dmcontrol should be read back until dmactive=1, which indicates that the debug module is fully operational. When 0, the DM TileLink clock is gated off to save power.
1	ndmreset	RW	Write 1 to reset system (assert ndreset output). Write 0 to operate normally.
2	clrresethaltreq	RW	Clear reset-halt-request bit.
3	setresethaltreq	RW	When written to 1, the core will halt upon the next deassertion of its reset.
[15:4]	Reserved		
[25:16]	hartsel	RW	Selects the hart to operate on.
26	hasel	RW	Not supported.
27	Reserved		
28	ackhavereset	RW	Write 1 to acknowledge that a reset occurred on the selected hart.
29	Reserved		
30	resumereq	RW	Write 1 to request selected hart to resume, cleared to 0 automatically when hart resumes.
31	haltreq	RW	Write 1 to request selected hart to halt. Generates debug interrupt to the core. Write 0 once halted has been set by the DM.

**Table 103:** Debug Module Control Register

### 12.5.3 Hart Info Register (hartinfo)

hartinfo contains information about the currently selected hart.

<b>Hart Info Register (hart.info)</b>			
<b>DMI Address</b>		<b>0x12</b>	
<b>Bits</b>	<b>Field Name</b>	<b>Attr.</b>	<b>Description</b>
[11:0]	dataaddr	RO	Address of DATA registers in hart memory map. 0x380 for SiFive.
[15:12]	datasize	RO	Number of DATA registers. 1 for 32-bit, 0x2 for 64-bit SiFive cores.
16	dataaccess	RO	DATA registers are shadowed in the hart memory map. 1 for SiFive.
[19:17]	Reserved		
[23:20]	nscratch	RO	Number of dscratch registers available for debugger. 1 for SiFive.
[31:24]	Reserved		

**Table 104:** Hart Info Register

### 12.5.4 Abstract Control and Status Register (abstractcs)

Abstract Control and Status Register (abstractcs)			
DMI Address		0x16	
Bits	Field Name	Attr.	Description
[3:0]	datacount	RW	Number of DATA registers. 0x1 for 32-bit, 0x2 for 64-bit SiFive cores.
[7:4]	Reserved		
[10:8]	cmderr	RW	<p>Non-zero value indicates an abstract command error. Remains set until cleared by writing all ones. If set, no abstract commands are accepted.</p> <ul style="list-style-type: none"> <li>• 0x0 - No error</li> <li>• 0x1 - Busy. Abstract command or register was accessed while command was running.</li> <li>• 0x2 - Not supported. Abstract command type not supported by hardware was attempted.</li> <li>• 0x3 - Exception. An exception occurred during execution of an abstract command.</li> <li>• 0x4 - Halt/resume. Abstract command attempted while hart was running or unavailable.</li> <li>• 0x5 - Bus. Bus error occurred during abstract command. Not used by SiFive.</li> <li>• 0x7 - Other. Abstract command failed for another reason. Not used by SiFive.</li> </ul>
11	Reserved		
12	busy	RW	Reads as 1 while Abstract command is running, 0 if not.
[23:13]	Reserved		
[28:24]	progbufsize	RW	Number of 32-bit words in PROGBUF. Typically 16 for SiFive (some configs have less).
[31:29]	Reserved		

**Table 105:** Abstract Control and Status Register

### 12.5.5 Abstract Command Register (command)

Abstract Command Register (command)			
DMI Address		0x17	
Bits	Field Name	Attr.	Description
[15:0]	regno	RW	Select which register to read/write. SiFive only supports GPRs: 0x1000-0x101F.
16	write	RW	1=write register, 0=read register. Only done if transfer=1.
17	transfer	RW	1=do the register read/write, 0=don't.
18	postexec	RW	1=execute PROGBUF after the command, 0=don't.
19	aarpostincrement	RW	Not supported by SiFive.
[22:20]	aarsize	RW	0x2, 0x3, 0x4 select 32, 64, 128 bits, respectively.
23	Reserved		
[31:24]	cmdtype	RW	0=Access Register is the only type supported by SiFive.

**Table 106:** Abstract Command Register

### 12.5.6 Abstract Command Autoexec Register (abstractauto)

Abstract Command Autoexec Register (abstractauto)			
DMI Address		0x18	
Bits	Field Name	Attr.	Description
[11:0]	autoexecdata	RW	Bitmap of DATA registers [11:0]. 1 indicates DATA access initiates command.
[15:12]	Reserved		
[31:16]	autoexecprogbuf	RW	Bitmap of PROGBUF words [15:0]. 1 indicates PROGBUF access initiates command.

**Table 107:** Abstract Command Autoexec Register

**12.5.7 Debug Module Control and Status 2 Register (dmcs2)**

Debug Module Control and Status 2 Register (dmcs2)			
DMI Address		0x32	
Bits	Field Name	Attr.	Description
0	hgselect	RW	0=operate on harts, 1=operate on external triggers.
1	hgwrite	RW	When written with 1, the selected harts or external trigger is assigned to halt group haltgroup.
[6:2]	group	RW	Specify the halt group or resume group number that the selected harts or external triggers will be assigned to.
[10:7]	exttrigger	RW	Select which external trigger to act upon if hgwrite and hgselect are written to 1 in the same write.
11	groupType	RW	0=operate on Halt Group configuration, 1=operate on Resume Group configuration.
[31:11]	Reserved		

**Table 108:** Debug Module Control and Status 2 Register**12.5.8 Abstract Commands**

Abstract commands provide a debugger with a path to read and write processor state and are used for extracting and modifying processor state such as registers and memory. Register `s0` is saved by the ROM and is available for use by the abstract command code. An abstract command is started by the debugger writing to `command`. In `command`, the debugger selects whether to load/store a register, execute `PROGBUF`, or both. Only GPR register transfers are supported currently. Many aspects of Abstract Commands are optional in the RISC-V Debug Spec and are implemented as described below.



cmdtype	Feature	Support
Access Register	GPR registers	Access Register command, register number 0x1000 - 0x101F
	CSR registers	Not supported. CSRs are accessed using the Program Buffer.
	FPU registers	Not supported. FPU registers are accessed using the Program Buffer.
	Autoexec	Both autoexecprogbuf and autoexecdata are supported.
	Post-increment	Not supported.
	Core Register Access	Not supported.
Quick Access		Not supported.
Access Memory		Not supported. Memory access is accomplished using the Program Buffer.

**Table 109:** Debug Abstract Commands

The use of abstract commands is outlined in the following example, describing how to read a word of target memory:

1. The debugger writes opcodes to PROGBUF to accomplish the desired function.
2. The debugger writes the desired memory address to DATA[0].
3. The debugger requests an abstract command specifying to load s0 from DATA[0], then execute PROGBUF. Writing to command while hart n is selected has the side effect of setting FLAGS[n].go. Writing to command also sets busy which is readable from the debugger, and indicates that an abstract command is in progress.
4. The ROM busy-wait loop being executed by hart n sees FLAGS[n].go set.
5. ROM code writes 0 to GOING which has the effect of clearing FLAGS[n].go.
6. ROM code jumps to WHERETO, then ABSTRACT which contains the opcode lw s0, 0(DATA) to load s0 from DATA[0]. Opcodes in ABSTRACT are constructed by DM hardware from command. If command.transfer=0, no register transfer is done and instead ABSTRACT[0] reads as NOP.
7. If a register read/write is all that is needed, the debugger would set command.postexec to 0. ABSTRACT[1] would then read as EBREAK.
8. If command.postexec=1, ABSTRACT[1] reads as NOP and execution falls through to PROGBUF which will have been previously written by the debugger with the opcodes lw s0, 0(s0), then sw s0, DATA(zero), then EBREAK.
9. EBREAK reenters ROM at address 0x800. ROM writes hartid to HALTED which has the side effect of clearing busy, telling the debugger that the abstract command is finished.
10. The debugger reads the result from DATA[0].

The autoexec feature of Abstract Commands is supported by SiFive hardware (and is used by OpenOCD for memory block read and write). Once an abstract command has been completed, the debugger can read or write a particular DATA or PROGBUF location to run the command again. For example, fast download can be accomplished by setting up PROGBUF for memory write, then repeatedly writing words to DATA[0]. Each write re-executes the register transfer and PROGBUF to store the word into memory. For a 32-bit block write, the abstract command would be set up like this:

ABSTRACT	regno=s1, write=1, transfer=1, postexec=1. DM constructs the instructions  lw s1,0(DATA) // load s1 from debugger NOP // fall thru to PROGBUF
PROGBUF	sw s1, 0(s0) // store s1 to memory addi s0, s0, 4 // increment memory pointer ebreak // done

**Table 110:** Abstract Command Example for 32-bit Block Write

### 12.5.9 System Bus Access

System Bus Access (SBA) provides an alternative method to access memory. SBA operation conforms to the RISC-V Debug Spec and the description is not duplicated here. It implements a bus master that connects with the bus crossbar to allow access to the device's physical address space without involving a hart to perform accesses. SBA is controlled from the DMI using registers in the range 0x37 - 0x3F. By default, the maximum bus width supported by SBA is 32. Comparing Program Buffer memory access and SBA:

Program Buffer Memory Access	SBA Memory Access
Physical Address	Physical Address
Subject to Physical Memory Protection (PMP)	Not subject to PMP
Cache coherent	Cache coherent
Hart must be halted	Hart may be halted or running

**Table 111:** System Bus vs. Program Buffer Comparison

## 12.6 Debug Module Operational Sequences

The sections below describe the flow for entering into and exiting from debug mode. The user can halt and resume more than one hart at a time using the hart array mask.

### 12.6.1 Entering Debug Mode

To use debug mode, the DM must be enabled by writing 0x0000\_0001 to dmcontrol.

The debugger can request a halt by writing 0x8000\_0001 to dmcontrol to set haltreq. This generates a debug interrupt to the core.

The core enters debug mode and jumps to the debug interrupt handler located at 0x800 and serviced from the DM.

ROM code at 0x800 writes `hartid` into the HALTED register which has the effect of setting the halted bit for this hart. Halted bits are readable from the debugger and generally will be continually polled to check for breakpoints when a hart is running.

ROM code then busy-waits checking its hart-specific FLAGS register.

### 12.6.2 Exiting Debug Mode

The debugger writes 1 to `resumereq` in the `dmcontrol` register to restart execution. This clears `resumeack` and sets bit 1 of the FLAGS register for the selected hart.

The ROM busy-wait loop being executed by hart `n` sees `FLAGS[n].resume` set.

ROM code writes `hartid` to `RESUMING`, which has the effect of clearing `FLAGS[n].resume`, setting `resumeack`, and clearing `halted` for the hart.

ROM code then executes `dret` which returns to user code at the address currently in `dpc`.

The debugger sees `resumeack` and knows the resume was successful.

## Appendix A

# SiFive Core Complex Configuration Options

This section lists the key configuration options of the SiFive E3 Series Core Complex. The configuration for the E34 Core Complex is listed in `docs/core_complex_configuration.txt`.

### A.1 E3 Series

The E3 Series comes with the following set of configuration options. Note that the configuration may be limited to a fixed set of discrete options.

#### Modes and ISA

- Configurable number of Cores (1 to 8). In the case where more than one core is selected, all cores are configured the same.
- Optional support for RISC-V user mode
- Optional M, A, F, and D extensions
  - If M extension, configurable performance (1-cycle or 4-cycle)
- Configurable base ISA (RV32I or RV32E)
- Optional SiFive Custom Instruction Extension (SCIE)

#### On-Chip Memory

- Configurable Instruction Cache size (4 KiB to 64 KiB) and associativity (2-, 4-, or 8-way)
- Data Tightly-Integrated Memory (DTIM) or Data Cache:
  - If DTIM, then configurable size (4 KiB to 256 KiB) and base address
  - If Data Cache, then configurable size (4 KiB to 256 KiB) and associativity (2-, 4-, 8-, or 16-way)
- Optional L2 Cache with the following options:
  - Configurable size (128 KiB to 4 MiB), associativity (2-, 4-, 8-, 16-, or 32-way), and banks (1, 2, or 4)

- Configurable L1 to L2 bus width (32-, 64-, 128-, or 256-bit)

### Error Handling

- Optional Bus-Error Unit
- Optional ECC support

### Ports

- Optional Memory Port, System Port, Peripheral Port, and Front Port
  - Each port has a configurable base address, size, and protocol (AHB, AHB-Lite, APB, or AXI4)
  - If AXI4 protocol, configurable AXI ID width (4, 8, or 16). Front, Memory, and System Ports only.

### Security

- Optional Physical Memory Protection, configurable up to 16 regions
- Optional Disable Debug Input
- Optional Password-protected Debug
- Optional Hardware Cryptographic Accelerator (HCA) with the following options:
  - Configurable base address
  - Optional AES-128/192/256
  - Optional AES-MAC
  - Optional SHA-224/256/384/512
  - Optional True Random Number Generator (TRNG)
  - Optional Public Key Accelerator (PKA) with the following parameters:
    - Configurable PKA operation maximum width (256- or 384-bits)

### Debug

- Optional Debug Module with the following options:
  - Configurable base address
  - Configurable debug interface (JTAG, cJTAG, or APB)
  - Configurable number of Hardware Breakpoints (0 to 16) and External Triggers (0 to 16)
  - Optional System Bus Access
- Configurable number of performance counters (0 to 8)
- Optional Raw Instruction Trace Port
- Optional Nexus Trace Encoder with the following options:

- Configurable Trace Encoder Format (BTM or HTM)
- Trace Sink (SRAM, ATB Bridge, SWT, System Memory, and/or PIB)
  - If SRAM Sink, configurable Trace Buffer size (256 B to 64 KiB)
  - If PIB Sink, configurable width (1-, 2-, 3-, 5-, or 9-bit) and optional PIB clock input
- Optional Timestamp capabilities with configurable width (40, 48, or 56 bits) and source (Bus Clock, Core Clock, or External)
- External Trigger Inputs (0 to 8) and Outputs (0 to 8)
- Optional Instrumentation Trace Component (ITC)
- Optional PC Sampling

### Interrupts

- Optional Platform-Level Interrupt Controller (PLIC) with the following parameters:
  - Priority Levels (1 to 7)
  - Number of interrupts (1 to 511)
- A configurable number of Core-Local Interruptor (CLINT) interrupts (0 to 16)

### Design For Test

- Configurable SRAM user-defined inputs (0 to 1024)
- Configurable SRAM user-defined outputs (0 to 1024)

### Clocks and Reset

- Optional Clock Gating
- Configurable Reset Scheme (Synchronous, Asynchronous, Full Asynchronous with separate GPR reset)

### Branch Prediction

- Configurable number of Branch Target Buffer (BTB) entries (5 to 60)
- Configurable number of Branch History Table (BHT) entries (128 to 1024)
- Configurable number of Return Address Stack (RAS) entries (2 to 12)

### RTL Options

- Optional custom RTL module name prefix

## Appendix B

# SiFive RISC-V Implementation Registers

This section provides a reference to the SiFive RISC-V implementation version registers `marchid` and `mimpid`.

### B.1 Machine Architecture ID Register (`marchid`)

Value	Core Generator
0x1	3/5-Series Processor (E3, S5, U5 series)

**Table 112:** Core Generator Encoding of `marchid`

### B.2 Machine Implementation ID Register (`mimpid`)

Value	Generator Release Version
0x0000_0000	Pre-19.02
0x2019_0228	19.02
0x2019_0531	19.05
0x2019_0919	19.08p0p0 / 19.08.00
0x2019_1105	19.08p1p0 / 19.08.01.00
0x2019_1204	19.08p2p0 / 19.08.02.00
0x2020_0423	19.08p3p0 / 19.08.03.00
0x0120_0626	19.08p4p0 / 19.08.04.00
0x0220_0515	koala.00.00-preview and koala.01.00-preview
0x0220_0603	koala.02.00-preview
0x0220_0630	20G1.03.00 / koala.03.00-general
0x0220_0710	20G1.04.00 / koala.04.00-general
0x0220_0826	20G1.05.00 / koala.05.00-general
0x0320_0908	kiwi.00.00-preview
0x0220_1013	20G1.06.00 / koala.06.00-general
0x0220_1120	20G1.07.00 / koala.07.00-general
0x0421_0205	llama.00.00-preview
0x0421_0324	21G1.01.00 / llama.01.00-general

**Table 113:** Generator Release Encoding of `mimpid`

## Appendix C

# Floating-Point Unit Instruction Timing

This section provides a reference for the instruction timings of the single-precision floating-point unit in the E34 Core Complex.

### C.1 E3 Floating-Point Instruction Timing

Single-precision floating-point unit instruction latency and repeat rates are described in Table 114.



Assembly	Operation	Latency	Repeat Rate
<b>Sign Inject</b>			
fabs.s rd, rs1	$f[rd] =  f[rs1] $	4	1
fsgnj.s rd, rs1, rs2	$f[rd] = \{f[rs2][31], f[rs1][30:0]\}$	4	1
fsgnjn.s rd, rs1, rs2	$f[rd] = \{-f[rs2][31], f[rs1][30:0]\}$	4	1
fsgnjx.s rd, rs1, rs2	$f[rd] = \{f[rs1][31] \wedge f[rs2][31], f[rs1][30:0]\}$	4	1
<b>Arithmetic</b>			
fadd.s rd, rs1, rs2	$f[rd] = f[rs1] + f[rs2]$	4	1
fsub.s rd, rs1, rs2	$f[rd] = f[rs1] - f[rs2]$	4	1
fdiv.s rd, rs1, rs2	$f[rd] = f[rs1] \div f[rs2]$	4–29	1–25
fmul.s rd, rs1, rs2	$f[rd] = f[rs1] \times f[rs2]$	4	1
fsqrt.s rd, rs1	$f[rd] = \sqrt{f[rs1]}$	4–28	1–29
fmadd.s rd, rs1, rs2, rs3	$f[rd] = (f[rs1] \times f[rs2]) + f[rs3]$	4	1
fmsub.s rd, rs1, rs2, rs3	$f[rd] = (f[rs1] \times f[rs2]) - f[rs3]$	4	1
<b>Negate Arithmetic</b>			
fneg.s rd, rs1	$f[rd] = -f[rs1]$	4	1
fnmadd.s rd, rs1, rs2, rs3	$f[rd] = -(f[rs1] \times f[rs2]) - f[rs3]$	4	1
fnmsub.s rd, rs1, rs2, rs3	$f[rd] = -(f[rs1] \times f[rs2]) + f[rs3]$	4	1
<b>Compare</b>			
feq.s rd, rs1, rs2	$x[rd] = f[rs1] == f[rs2]$	3	1
fle.s rd, rs1, rs2	$x[rd] = f[rs1] \leq f[rs2]$	3	1
flt.s rd, rs1, rs2	$x[rd] = f[rs1] < f[rs2]$	3	1
fmax.s rd, rs1, rs2	$f[rd] = \max(f[rs1], f[rs2])$	4	1
fmin.s rd, rs1, rs2	$f[rd] = \min(f[rs1], f[rs2])$	4	1
<b>Categorize</b>			
fclass.s rd, rs1	$x[rd] = \text{classify}_s(f[rs1])$	3	1
<b>Convert Data Type</b>			
fcvt.w.s rd, rs1	$x[rd] = \text{sext}(s32_{f32}(f[rs1]))$	3	1
fcvt.l.s rd, rs1	$x[rd] = s64_{f32}(f[rs1])$	N/A	N/A
fcvt.s.w rd, rs1	$f[rd] = f32_{s32}(x[rs1])$	4	1
fcvt.s.l rd, rs1	$f[rd] = f32_{s64}(x[rs1])$	N/A	N/A
fcvt.wu.s rd, rs1	$x[rd] = \text{sext}(u32_{f32}(f[rs1]))$	3	1
fcvt.lu.s rd, rs1	$x[rd] = u64_{f32}(f[rs1])$	N/A	N/A
fcvt.s.wu rd, rs1	$f[rd] = f32_{u32}(x[rs1])$	4	1
fcvt.s.lu rd, rs1	$f[rd] = f32_{u64}(x[rs1])$	N/A	N/A
<b>Move</b>			
fmv.s rd, rs1	$f[rd] = f[rs1]$	4	1
fmv.w.x rd, rs1	$f[rd] = x[rs1][31:0]$	4	1
fmv.w.x `rd, rs1	$x[rd] = \text{sext}(f[rs1][31:0])$	3	1
<b>Load/Store</b>			
flw rd, offset(rs1)	$f[rd] = M[x[rs1] + \text{sext}(\text{offset})][31:0]$	4	1
fsw rs2, offset(rs1)	$M[x[rs1] + \text{sext}(\text{offset})] = f[rs2][31:0]$	3	1

**Table 114:** E3 Single-Precision FPU Instruction Latency and Repeat Rates

# References

Visit the SiFive forums for support and answers to frequently asked questions:  
<https://forums.sifive.com>

[1] A. Waterman and K. Asanovic, Eds., The RISC-V Instruction Set Manual, Volume I: User-Level ISA, Version 2.2, June 2019. [Online]. Available: <https://riscv.org/specifications/>

[2] —, The RISC-V Instruction Set Manual Volume II: Privileged Architecture Version 1.11, June 2019. [Online]. Available: <https://riscv.org/specifications/privileged-isa>

[3] —, SiFive TileLink Specification Version 1.8.0, August 2019. [Online]. Available: <https://sifive.com/documentation/tilelink/tilelink-spec>

[4] A. Chang, D. Barbier, and P. Dabbelt, RISC-V Platform-Level Interrupt Controller (PLIC) Specification. [Online]. Available: <https://github.com/riscv/riscv-plic-spec>